

Accumulatore GEL MKC12-150LL

12V 150A Long Life 10 anni
Art. 491460325



Proposte & Novità

































Giugno 2026

SFOGLIA ALL'INTERNO LE NOSTRE GAMME



Batterie e Alimentatori
Illuminazione
Cavi e Materiale Elettrico
Automazione
Utensili e Strumentazione
Componenti Elettronici
Connettori
Audio
TV e Satellite
Informatica e Office

I NOSTRI CONTENUTI

Pag. 4		GRUPPI DI CONTINUITÀ UPS MKC
Pag. 5		BATTERIE ERMETICHE e CARICABATTERIE: Litio, Piombo
Pag. 9		RICARICHE FOTOVOLTAICHE, PPS e WALLBOX MELCHIONI
Pag. 13		BATTERIE E CARICABATTERIE: Litio, Alkaline, Ni-Cd, Ni-Mh, Zinco Carbone, ...
Pag. 21		POWER: Alimentatori, Regolatori di tensione, Stabilizzatori monofase e Inverter
Pag. 30		MATERIALE ELETTRICO, CRONOTERMOSTATI e TIMER
Pag. 37		AUDIO VIDEO: Cavi HDMI, Audio video sender, Supporti per TV, casse e VDP
Pag. 44		TV SAT: Accessori, Antenne DTT, Antenne Sat, LNB, Cavi
Pag. 51		TELECOMANDI: Universali, Semplificati, Decoder SKY, Dedicati, accessori
Pag. 54		SENSORI MKC: Rilevatori di fumo, CO, gas GPL e metano, alcool tester
Pag. 55		IRRADIO - HOM-IO: Smart home automation and Security
Pag. 59		SECURITY, VIDEOSORVEGLIANZA e RADIOCOMUNICAZIONE
Pag. 63		GRUPPI DI CONTINUITÀ - UPS - ARMADI RACK e Alimentazione PC
Pag. 67		CAVI LAN e fibra ottica; Connettori, prese, accoppiatori Cat5/Cat6; Utensileria
Pag. 73		EWENT: Gaming, Informatica e Office
Pag. 75		DYMO: Prodotti per l'etichettatura
Pag. 77		UTENSILERIA e MINUTERIA
Pag. 82		SALDATURA e LABORATORIO
Pag. 88		STRUMENTAZIONE
Pag. 93		SMART PHOTO FRAME, DECODER
Pag. 94		ENTERTAINMENT AUDIO/VIDEO: Videoproiezione, Sistemi stereo, ...
Pag. 100		HOME AUDIO: Diffusori wireless, boombox, party speaker, cuffie, occhiali smart
Pag. 109		PA: Mixer, Luci ed effetti, Amplificazione, Diffusione, Microfoni e radiomic.
Pag. 119		TELEFONIA: Telefoni a filo e cordless, Accessori e Connettori
Pag. 121		ILLUMINAZIONE: Torce LED e Lampade da lavoro, Illuminazione da giardino
Pag. 123		STAZIONI BAROMETRICHE
Pag. 124		COMPONENTISTICA, ELETTRMECCANICA, VENTOLE
Pag. 136		CONDENSATORI DI SPUNTO
Pag. 138		ASSEMBLAGGIO, REPELLENTI, SEGNALATORI ACUSTICI ED OTTICI
Pag. 139		PRODOTTI CHIMICI PER LA MANUTENZIONE
Pag. 140		CONDIZIONATORI D'ARIA e DEUMIDIFICATORI
Pag. 143		RISCALDAMENTO, VENTILAZIONE, ZANZARIERE, FRIGO PORTATILI



GRUPPI DI CONTINUITÀ UPS MKC

La linea **UPS MK** è la gamma ideale per la protezione completa da blackout e sbalzi di tensione. Ideale per il funzionamento continuo di tutte le apparecchiature domestiche e per ufficio quali computer, DVR/NVR e sistemi video sorveglianza, modem adsl/fibra, switch/router, registratori di cassa.

- Circuito elettronico di stabilizzazione tensione AVR
- Sistema di riaccensione e ricarica automatica
- Prese d'uscita protette da blackout
- Prese d'uscita protette da sovratensioni
- Basso livello di rumorosità



ARTICOLO	MODELLO	POTENZA NOMINALE	POTENZA ATTIVA	M.O.	PREZZO €
480820001	MK-650UPS	650 VA	360 W	1	67,27
480820002	MK-800UPS	800 VA	480 W	1	79,51
480820003	MK-1200UPS	1200 VA	600 W	1	141,67
480820004	MK-1500UPS	1500 VA	900 W	1	172,83
480820005	MK-2000UPS	2000 VA	1200 W	1	241,99



MINI UPS MKC

MK-7800
MINI DC UPS 7800Mah
9V-12V



Art. 480820050
€ 30,60 M.O.:7

MK-8800
MINI DC UPS 8800Mah
5V-9V-12V LAN



Art. 480820055
€ 43,44 M.O.:7

ALIMENTATORI FORATI CON FUNZIONE CARICABATTERIE MKC

NOVITÀ

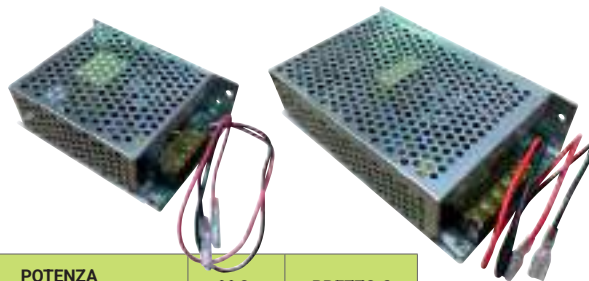

ARTICOLO	MODELLO	POTENZA CAPACITÀ TENSIONE	M.O.	PREZZO €
530137060	MKC35UPS-12	35W 3A 12V	1	21,58
530137061	MKC35UPS-24	35W 3A 24V	1	21,58
530137062	MKC60UPS-12	60W 5A 12V	1	35,42
530137063	MKC60UPS-24	60W 5A 24V	1	35,42
530137064	MKC120UPS-12	120W 10A 12V	1	45,33
530137065	MKC120UPS-24	120W 10A 24V	1	45,33

La nuova serie di alimentatori forati **MK-XX-UPS** sono alimentatori switching da quadro elettrico ideali per *applicazioni di Videosorveglianza, TVCC e sicurezza.*

Questi alimentatori, oltre alla funzione di base di fornire uscita stabilizzata, integrano anche quella di caricabatterie e UPS e quindi sono progettati per garantire continuità operativa a dispositivi critici come sistemi di videosorveglianza, router o apparati di rete.

Compatibili sia con batterie al piombo da **12V** sia con celle al litio da **12.5V**, integrano un circuito intelligente per la gestione della carica e il passaggio automatico alla batteria in caso di interruzione della corrente. Al ritorno dell'alimentazione, il sistema ripristina automaticamente la rete e ricarica la batteria.

Includono protezioni contro *sovratensione, sovracorrente, cortocircuito, inversione di polarità e scarica profonda.*



BATTERIE ERMETICHE AL LITIO

Batterie ricaricabili Litio Ferro Fosfato (LiFePO4)

Principali vantaggi della tecnologia LiFePO4

- Vita utile della batteria superiore fino a 10 volte
 - Maggiore autonomia della batteria
 - Peso notevolmente ridotto, fino a -70%
 - Scarica più efficiente
 - Tempi di ricarica più rapidi
- Ideali per**
- UPS
 - Solare
 - Mobilità elettrica
 - Sicurezza



ARTICOLO	MODELLO	DESCRIZIONE	CELLE	TENSIONE	CAPACITÀ	PESO	TERMINALI	DIMENSIONI	M.O.	PREZZO €
491463602	MKC LFP1290	Batteria LiFePO4 12,8V 9Ah - 4S	Li-Fe	12,8V	9Ah	1,2 kg	T2	151 x 65 x 94	1	87,87
491463605	MKC LFP1212	Batteria LiFePO4 12,8V 12Ah - 4S	Li-Fe	12,8V	12Ah	1,4 kg	T2	151 x 99 x 96	1	99,14
491463610	MKC LFP1218	Batteria LiFePO4 12,8V 18Ah - 4S	Li-Fe	12,8V	18Ah	2,9 Kg	M5	181 x 77 x 167	1	150,96
491463615	MKC LFP12100	Batteria LiFePO4 12,8V 100Ah - 4S	Li-Fe	12,8V	100Ah	12 Kg	M8	330 x 175 x 216	1	946,31
491463620	MKC LFP2410	Batteria LiFePO4 24V 10Ah - 4P	Li-Fe	24V	10Ah	2,5 Kg	M5	181 x 77 x 167	1	178,00

CARICABATTERIE PER BATTERIE AL PIOMBO

MKC-2612T
Caricabatterie
per batterie al piombo
2V - 6V- 12V 230Vca
500mAh



Art. 491929119
€ 22,61 M.O.:1

Caricabatterie
per batterie al piombo
6/12/24 Vdc 1200mAh



Art. 491929242
€ 39,40 M.O.:1

Carica batterie
per batterie
ricaricabili
al piombo 6V
600mAh



Art. 491929343
€ 15,44 M.O.:1

CARICABATTERIE PER BATTERIE AL PIOMBO E AL LITIO

MKC-001P
Caricabatterie per batterie
al piombo 6/12V 1A
SLA - AGM GEL - Litio



Art. 491929870
€ 39,17 M.O.:1

**adatti per
AUTO E MOTO**

BATTERIE AL PIOMBO

**contributo
di smaltimento
incluso nel prezzo**



ARTICOLO	MODELLO	TENSIONE	INTENSITÀ	FASTON	M.O.	PREZZO €
491460230	MKC4V-3	4V	3A	4.8 mm	5	8,21
491460201	MKC612	6V	1.2A	4.8 mm	5	7,52
491460219	MKC632C	6V	3.2A	4.8 mm	1	11,52
491460252	MKC632L	6V	3.2A	4.8 mm	5	11,19
491460227	MKC632B	6V	3.2A	4.8 mm	5	12,93
491460225	MKC4-6L	6V	4A	c/ cavo e connettore	5	14,04
491460216	MKC640	6V	4A	4.8 mm	1	8,50
491460202	MKC645	6V	4.5A	4.8 mm	1	10,59
491460209	MKC670	6V	7A	4.8 mm	5	16,11
491460203	MKC6120	6V	12A	4.8 mm	1	22,85
491460241	MKC1208	12V	0.8A	c/ cavo e connettore	5	12,15
491460205	MKC1212	12V	1.2A	4.8 mm	1	9,73
491460206	MKC1223	12V	2.3A	4.8 mm	1	12,67
491460213	MKC1229	12V	2.9A	T1	1	21,99
491460221	MKC1235	12V	3.5A	4.8 mm	1	26,97
491460207	MKC1245	12V	4.5A	4.8 mm	2	22,24
491460217	MKC 1250SLIM	12V	5A	T1	5	24,43
491460215	MKC1270P	12V	7A	4.8 mm	5	21,21
491460222	MKC1270G	12V	7A	6.3 mm	5	22,65
491460250	MKC1272P	12V	7.2A	4.8 mm	5	25,70
491460251	MKC1272G	12V	7.2A	6.3 mm	5	25,70
491460214	MKC1290	12V	9A	6.3 mm	5	31,72
491460212	MKC12120	12V	12A	6.3 mm	1	45,60
491460228	MKC 12120-1	12V	12A	4.8 mm	1	45,60
491460208	MKC12180	12V	18A	T3	1	62,22
491460210	MKC12250	12V	25A	T3	1	102,97
491460260	MKC12-330	12V	33A	T6	1	123,06
491460265	MKC12-400	12V	40A	T6	1	169,25
491460268	MKC12-550	12V	55A	T6	1	243,54
491460270	MKC12-650	12V	65A	T6	1	272,53
491460271	MKC12-800	12V	80	M6	1	320,47
491460275	MKC12-100X	12V	100A	T11	1	398,75

CICLICHE

491460278	MKC1272H	12V	7.2A	6.3 mm	5	34,14
491460279	MKC1290H	12V	9A	6.3 mm	5	35,15
491460280	MKC12-12H	12V	12A	6.3 mm	4	57,08
491460290	MKC1214H	12V	14A	6.3 mm	4	64,70
491460281	MKC12-18H	12V	18A	T3	2	77,14
491460284	MKC12-40H	12V	40A	T6	1	197,94
491460285	MKC12-55H	12V	55A	T6	1	284,01
491460273	MKC12-80H	12V	80A	M6	1	342,59
491460287	MKC12-100H	12V	100A	T11	1	473,33
491460288	MKC12-120H	12V	120A	T11	1	494,10



BATTERIE AL PIOMBO

ZODIAC
Energy

contributo
di smaltimento
incluso nel prezzo



ARTICOLO	MODELLO	TENSIONE	INTENSITÀ	FASTON	M.O.	PREZZO €
491460218	Z1270	12V	7A	4.8 mm	1	16,00
491460220	Z1220	12V	2.3A	4.8 mm	10	16,00
491460223	Z1218	12V	18A	T3	1	43,33

ACCUMULATORI AL GEL MKC

Batterie ricaricabili al GEL MKC

Gli accumulatori al **GEL MKC** sono batterie ad alte prestazioni, ideali per **impianti di videosorveglianza, UPS, sistemi di telecomunicazione, veicoli elettrici e applicazioni industriali.**

melchioni
mkc

Grazie alla tecnologia **VRLA** (Valve Regulated Lead Acid) con elettrolita gelificato, garantiscono una durata **fino a 10 anni in modalità stand-by** e **fino a 700 cicli in uso ciclico** (al 50% di scarica). Totalmente sigillate e senza bisogno di manutenzione, offrono elevata resistenza a scariche profonde, autoscarica ridotta e ottima efficienza anche in ambienti critici.



contributo
di smaltimento
incluso nel prezzo

ARTICOLO	MODELLO	TENSIONE	INTENSITÀ	TERMINALI	M.O.	PREZZO €
491460320	MKC12-55LL	12V	55A	M6	1	197,92
491460321	MKC12-70LL	12V	70A	M6	1	227,08
491460322	MKC12-80LL	12V	80A	M6	1	247,92
491460323	MKC12-100LL	12V	100A	M6	1	331,25
491460324	MKC12-120LL	12V	120A	M8	1	406,25
491460325	MKC12-150LL	12V	150A	M8	1	518,75

BATTERIE AL PIOMBO

FIAMM

contributo di smaltimento incluso nel prezzo



ARTICOLO	MODELLO	TENSIONE	INTENSITÀ	M.O.	PREZZO €
491460366	FG21803	12V	18A	1	104,78
491460369	12FGH23	12V	5A	1	45,24
491460370	FG20721	12V	7.2A	1	37,00
491460383	12FGH36	12V	9A	1	52,43
491460360	FG20121A	12V	1.2A	1	19,85
491460362	FG20201	12V	2A	1	23,35
491460449	FG22703	12V	27A	1	141,86
491460454	FG20451	12V	4.5A	1	33,20
491460455	FG20722	12V	7.2A	1	42,85
491460456	FG21202	12V	12A	1	75,92
491460475	12FGHL22	12V	5A	1	50,35
491460561	12FGL33	12V	33A	1	223,81
491460567	12FGL100	12V	100A	1	471,13

ARTICOLO	MODELLO	TENSIONE	INTENSITÀ	M.O.	PREZZO €
491460363	FG10121	6V	1.2A	1	13,80
491460364	FG10301	6V	3A	1	20,58
491460365	FG10451	6V	4.5A	1	17,39
491460381	FG10381	6V	3.8A	1	24,10
491460368	FG11201	6V	12A	1	38,24
491460388	FG10721	6V	7.2A	1	25,57

contributo di smaltimento incluso nel prezzo



YUASA

ARTICOLO	MODELLO	TENSIONE	INTENSITÀ	M.O.	PREZZO €
491461500	NP1.2-6	6V	1.2A	1	22,27
491461501	NP2.8-6	6V	2.8A	1	32,25
491461502	NP4-6	6V	4A	1	22,00
491461503	NP7-6	6V	7A	1	42,21
491461504	NP10-6	6V	10A	1	45,38
491461505	NP0.8-12	12V	0.8A	1	39,04
491461506	NP1.2-12	12V	1.2A	1	24,08
491461508	NP2.3-12	12V	2.3A	1	27,65
491461509	NP2.8-12	12V	2.8A	1	46,35
491461510	NP4-12	12V	4A	1	38,10
491461511	NP7-12	12V	7A	1	37,00
491461512	NP7-12L	12V	7A	1	37,00
491461513	NP12-12	12V	12A	1	75,23

ARTICOLO	MODELLO	TENSIONE	INTENSITÀ	M.O.	PREZZO €
491461514	NP17-12I	12V	17A	1	102,81
491461515	NP24-12I	12V	24A	1	152,46
491461516	NP38-12I	12V	38A	1	181,50
491461517	NP65-12I	12V	65A	1	371,10
491461518	SW280	12V	7.6A	1	46,10
491461542	SWL750	12V	22,9A	1	192,70
491461544	SWL1100	12V	-	1	257,73
491461520	NPC24-12 CICLICA	12V	24A	1	195,92
491461521	NPC38-12 CICLICA	12V	38A	1	273,75
491461522	NPC65-12 CICLICA	12V	65A	1	414,04
491461523	NPC100-12 CICLICA	12V	100A	1	737,81



RICARICHE FOTOVOLTAICHE

Impianto fotovoltaico da balcone

Nuovo impianto fotovoltaico Melchioni MKC con pannello solare, inverter e accessori inclusi.

Conforme alla normativa CEI 0-21

Ideale per chi desidera un impianto fotovoltaico smart ma con limitata disponibilità di spazi e vive in condominio. Semplice e veloce da installare sul tuo balcone, si connette alla rete tramite una spina elettrica con una presa di corrente dedicata che rispetta i requisiti espressi dalla norma CEI 0-21, permettendo un immediato risparmio sui consumi elettrici della casa. Disponibili in due configurazioni con potenza da 300W e 600W.



MODELLO CODICE	KIT BALCONE 300 art. 491463900	KIT BALCONE 600 art. 491463901
Potenza nominale	0.375 KWp	0.750 KWp
Tensione	31,36V	31,36V
Corrente	13,08A	13,108A
Energia prodotta stimata	300 W	600 W
N° pannelli	1	2
Potenza nominale pannello	375 Wp	375 Wp
Efficienza moduli pannello	>21%	>21 %
Tecnologia pannello	Silicio monocristallino	Silicio monocristallino
Specifiche celle	108 Half Cell	108 Half cell
Connettore pannello	Mc4	Mc4
Dimensione pannello	1724x1134x25 mm	1724x1134x25 mm
Peso pannello	20 Kg	20 Kg
Potenza max inverter AC in uscita	300 W	600 W
Potenza max inverter DC in ingresso	410 W	820 W
Efficienza inverter	96.5 %	96.5 %
Forma d'onda inverter	Sinusoidale pura	Sinusoidale pura
Connettività	WiFi	WiFi
Dimensioni inverter	185x160x32 mm	200x230x40 mm
Peso inverter	2.15 Kg	3.15 Kg
Resistenza a venti	100 Km/h	100 Km/h

Art. 491463900

€ 933,36 M.O.: 1

Art. 491463901

€ 1.421,38 M.O.: 1



* Il kit comprende pannello solare, inverter, cavo di rete e cavi di sicurezza

Benefici del nostro kit fotovoltaico

L'installazione del kit fotovoltaico da balcone consente un taglio immediato dei costi in bolletta fino al **25-30%**. Questo perché i pannelli producono complessivamente fino a **600 Watt** che vengono utilizzati per il fabbisogno quotidiano di energia della tua abitazione, andando a sgravare il consumo di energia abitualmente richiesto al tuo fornitore.

- **Risparmio in bolletta fino al 25-30%**
- **Nessuna pratica burocratica necessaria**
- **Nessuno costo di installazione**

Inizia a produrre energia

I nostri kit sono completi di tutto* quello che ti serve per installare l'impianto in autonomia e in modo semplicissimo senza la necessità di dovere realizzare particolari impianti o connessioni.

- **Installa i pannelli**
 - **Collega l'impianto all'inverter**
 - **Inserisci la spina in una normale presa di corrente**
- Fatto! Stai producendo la tua energia**

Il risparmio è garantito

I nostri kit producono energia che viene utilizzata direttamente dalla tua rete domestica riducendo la richiesta al fornitore.

- **Il kit immette energia nella rete domestica**
 - **Se la richiesta eccede la produzione il fornitore integra l'eccedenza**
 - **L'autoproduzione viene utilizzata tutta e l'eccedenza erogata dal fornitore**
- Questo sistema consente di usare prima l'energia autoprodotta, garantendo un risparmio netto sui consumi abituali.**

PORTABLE POWER STATIONS

Stazioni di ricarica portatile

Le stazioni di ricarica portatili Melchioni Ready sono compatte e ampiamente utilizzate sia come alimentatori di backup per interni, in mancanza di corrente domestica, che per alimentazione di apparecchiature da esterno o di emergenza.

Dimensioni e peso contenute grazie all'uso di batterie a litio

- Utilizzabile durante la carica con pannello solare
- Costruzione robusta: largo ricorso a lega e alluminio
- Monitoraggio costante in ingresso e uscita
- Previsione autonomia
- Affidabilità della prestazione dichiarata



Ricarica con pannello solare



Ciclo di vita prolungato



Eccellenti prestazioni di scarica



Nessuna manutenzione



Gamma di temperatura estesa



Garanzia



Elevate prestazioni di sicurezza

melchioni
mkc

MODELLO	600S / art. 400052073 [1]	1000S / art. 400052074 [2]
Peso	6.6 Kg	11 Kg
Capacità	577 Wh	1000.4 Wh
Dimensioni	286*158*150mm	340*231*206mm
Griglia	22V/10A max220W	22V/10A max220W
PV	DC18-24V / 100W Max	DC18-24V / 8A200W Max
Tipo-C	PD60W	PD100W
Ricarica auto	12~24V/5A (85W Max)	12~30V/5A max 150W
Uscita CA	600W 120 / 220V50 / 60Hz Pure Since Wave	1000W 120/220V50/60Hz Pure Since Wave
Uscita CC	12V*4total10A	12V*4total10A
Uscita caricabatteria per auto	12V 10A	12V 10A
USB	5V/2.4A*2; QC3.0,(5V/3A,9V/3A,12/1.5A)*1	5V/2.4A*2; QC3.0,(5V/3A,9V/3A,12/1.5A)*1
Tipo-C	5/9/12/15/20V3A, max60W	5/9/12/15V3A;20V/5A, max100W
Temperatura di carica	0~40°C	0~40°C
Temperatura di scarica	-10~45°C	-10~45°C
Temperature ambiente	-20~45°C	-20~45°C



AC/DC



USB



Type C



Car charger

Art. 400052073

€ 977,08

M.O.: 1

Art. 400052074

€ 1.739,58

M.O.: 1



Anderson socket



Pannelli solari portatili

I nuovi pannelli solari MKC sono completi di mini inverter con uscita USB-A, USB-C e connettore Jack con vari adattatori.

Possono essere utilizzati per alimentare direttamente apparecchiature a batteria (smartphone, laptop, tablet, etc..)

MINI INVERTER con uscita USB-A, USB-C e connettore Jack



Art. 400052075

€ 414,58

M.O.: 1

Art. 400052076

€ 518,75

M.O.: 1

MODELLO	Solar 100 / art. 400052075	Solar 120 / art. 400052076
Porte di uscita	Output 100W	Output 120W
Adatto per	Portable Power Station 200W / 300W / 500W / 1000W	
Dimensioni aperto (LxWxH)	1575 x 460 x 5 mm	1690 x 412 x 30 mm
Dimensioni chiuso (LxWxH)	440 x 460 x 45 mm	485 x 412 x 50 mm
Peso	3Kg	3Kg

ACCEDI AL SITO MELCHIONI-READY.COM PER VISUALIZZARE L'INTERA GAMMA DI PRODOTTI ►
Contattaci clienti-ready@melchioni.com | Segui MELCHIONI READY su LinkedIn



Postazioni di ricarica per auto

Melchioni presenta la Wallbox il nuovo dispositivo Made in Italy che preleva la corrente dall'utenza elettrica domestica e la trasmette, tramite cavo, all'auto a batteria.

Raccomandata per utilizzo domestico o in parcheggi privati e semipubblici. Se installata con **Dynamic Power Management** permette di modulare la potenza di ricarica per non superare il limite del contatore. La modalità **Solar Boost**, disponibile nella versione monofase, permette di sfruttare la potenza generata dai pannelli fotovoltaici prioritizzando il consumo dell'energia solare rispetto a quella prelevata da sistemi d'accumulo o dalla rete.

La stazione è comandabile via **App** da remoto quando è connessa a una rete Wi-Fi e, in assenza di connessione internet, è gestibile sempre da App grazie alla connettività Bluetooth. È inoltre possibile aggiornare il software sia tramite Wi-Fi che tramite Bluetooth. Tramite App è inoltre possibile monitorare i consumi delle singole sessioni, limitare l'accesso ai non autorizzati e programmare gli orari di blocco. È compatibile con sistemi di gestione di terze parti tramite protocollo di interoperabilità **OCPP 1.6**.



Specifiche generali	WALLBOX Monofase	WALLBOX Trifase
Mododi ricarica	Modo 3	Modo 3
Connessione	Cavo integrato, tipo 2	Cavo integrato, tipo 2
Lunghezza cavo	5,7 m	5,7 m
Dimens. (senza connettore)	335 x 227 x 102 mm	335 x 227 x 102 mm
Dimens. (con connettore)	335 x 227 x 285 mm	335 x 227 x 285 mm
Peso	~ 4 kg	~ 5 kg
Consumo in stand by	< 2 W	< 2 W
Specifiche elettriche	WALLBOX Monofase	WALLBOX Trifase
Connessione	N + L + T	N + L1 + L2 + L3 + T
Corrente massima	32A / 20A	32A
Potenza massima	7,4 kW	22,2 kW
Tensione	230V ±10%	400V ±10%
Frequenza	50-60Hz	50-60Hz
Configurazione di rete	TT / TN	TT / TN
Connettività	WALLBOX Monofase	WALLBOX Trifase
Connettività Bluetooth	BLE 4.2	BLE 4.2
Connettività WiFi	808.11 b/g/n	808.11 b/g/n
Aggiornamento software	Tramite Bluetooth o WiFi	Tramite Bluetooth o WiFi
Protocollo Internet interoperabilità	OCPP 1.6 Json	OCPP 1.6 Json
Protocollo con sistemi di gestione	Modbus RTU Rs485	Modbus RTU Rs485
Funzionalità	WALLBOX Monofase	WALLBOX Trifase
Indicazione di stato e messaggi	4 LED multicolore indipendenti	4 LED multicolore indipendenti
Interfaccia utenti	App Daze, Android o iOS	App Daze, Android o iOS
Blocco, sblocco, progr. oraria blocco	Tramite App	Tramite App
Reportistica consumi sess. ricarica	Tramite App	Tramite App
Dynamic Power Management	Opzionale, necessita 491463928	Opzionale, necessita 491463929
DPM compatibile con Solar Boost	Sì	No
Compatibile con ARERA-GSE	Sì	Sì
Sicurezza	WALLBOX Monofase	WALLBOX Trifase
Rilevamento correnti in continua (RCM)	Integrato, 6mA CC (permette utilizzo RCD tipo A)	
Monitoraggio temperatura	Integrato, con protezione surriscaldamento	
Rilevamento corretta apertura Relè	Integrato	
Sicurezza antincendio	UL94 V-0	
Classe isolamento	I	
Categoria di sovratensione	OVC III	
Resistenza ambientale	WALLBOX Monofase	WALLBOX Trifase
Grado di protezione IP e IK	IP55 e IK08	
Temperatura di funzionamento	da -25°C a 55°C	
Temperatura di stoccaggio	da -30°C a 60°C	
Massima altitudine di installazione	2000m s.l.m.	
Materiale involucro	Policarbonato ad alta resistenza	
Grado di inquadramento ammesso	PD2	
Installazione	WALLBOX Monofase	WALLBOX Trifase
Configurazione iniziale	tramite App o tramite Dip Switch su scheda	
Ancoraggio	a muro o su supporti 491463930 - 491463931	
Passaggio cavi	a giorno o sottotraccia	
Certificazioni	WALLBOX Monofase	WALLBOX Trifase
Certificazione	CE	
Norma di riferimento internazionale	IEC 61851-1, IEC 61851-21, IEC 62196-2	
Ente terzo certificato	IMQ	
Norma di riferimento nazionale	CEI EN 61851-1, CEI EN 61851-21-2, CEI EN 62196-2	

LED di stato

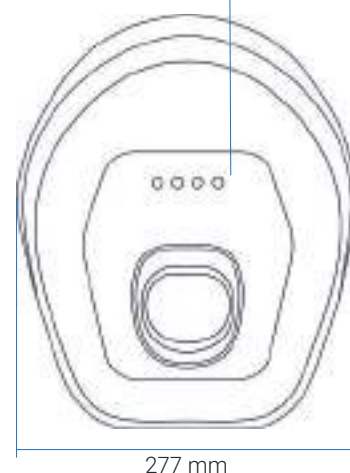

277 mm

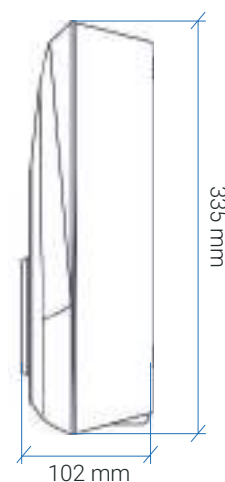

335 mm

102 mm

ARTICOLO	MODELLO	DESCRIZIONE	LUNGHEZZA CAVO	POTENZA MAX	PORTACAVO INCLUSO	M.O.	PREZZO €
491463920	MK-07-M5	Melchioni Wallbox con alimentazione Monofase	5 m	7,4 Kw	Si	1	1.016,69
491463921	MK-07-M7		7 m	7,4 Kw	Si	1	1.066,05
491463922	MK-07-T5	Melchioni Wallbox con alimentazione Trifase	5 m	22,2 Kw	Si	1	1.149,95
491463923	MK-07-T7		7 m	22,2 Kw	Si	1	1.223,98

Dynamic Power Management

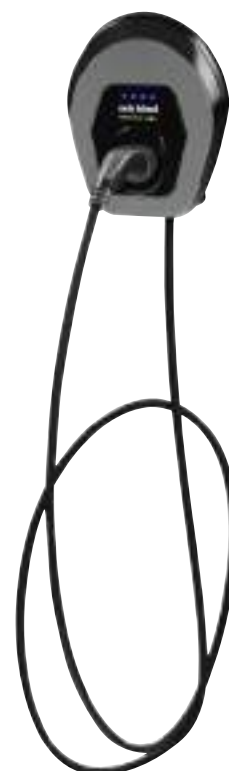
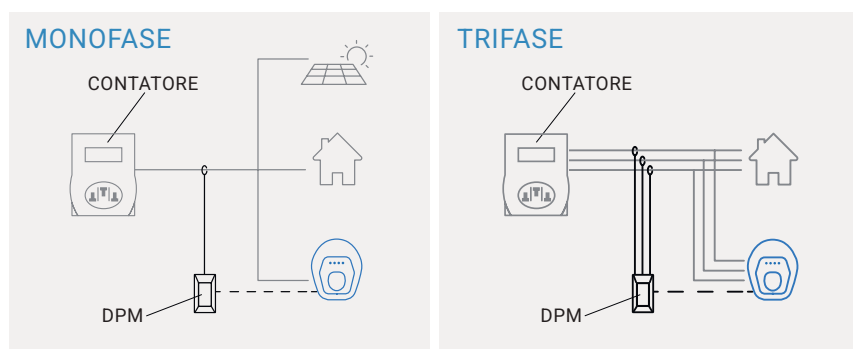

Specifiche generali	491463928 DPM Monofase	491463929 DPM Trifase
Compatibilità con Wallbox	MK-07-M5 MK-07-M7	MK-07-T5 MK-07-T7
Potenza massima contatore	10 kW	30 kW
Numero sensori corrente	1	3
Passaggio cavi sensore corrente	Fino a 16 mm ²	Fino a 16 mm ²
Cavo collegamento CT Box alla wallbox	Cavo di rete Cat 5 schermato	Cavo di rete Cat 5 schermato
Distanza massima CT Box dalla wallbox	170 m	170 m
Montaggio CT Box	Guida DIN o con viti	Guida DIN o con viti

Art. 491463928
€ 80,58 M.O.: 1

Art. 491463929
€ 118,45 M.O.: 1

Supporti

Specifiche generali	491463930 Totem MK-07-S130 491463931 Totem MK-07-S140
Dimensioni	1652 x 340 x 220 mm
Materiale	Acciaio + doppia verniciatura
Peso	~ 16 kg
Passaggio cavi di alimentazione	Sottotraccia

1 Art. 491463930
€ 592,25 M.O.: 1

2 Art. 491463931
€ 629,80 M.O.: 1

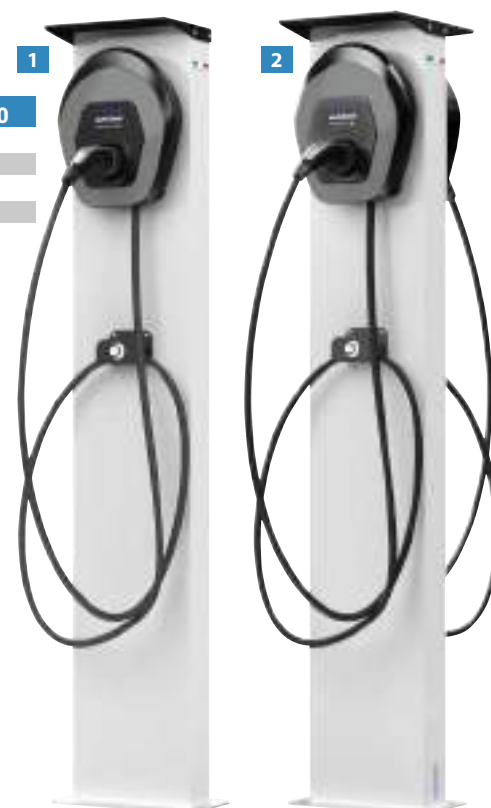

APP DAZE

Visualizzazione dati di ricarica, controllo da remoto e aggiornamento software

Reportistica consumo sessioni di ricarica



Configurazione parametri via App per installazione rapida



Google Play

App Store



BATTERIE AL LITIO

BATTERIE AGLI IONI DI LITIO 3,6 V RICARICABILI

ARTICOLO	TIPO	CAPACITÀ	TERMINALI	M.O.	PREZZO €
491463530	14500	600 mAh	piatto	4	4,34
491463531	14650	1000 mAh	piatto	4	7,23
491463532	18650	2000 mAh	piatto	4	5,81
491463533	18650	2600 mAh	piatto	4	8,09
491463534	18650	2000 mAh	lamelle	4	5,81
491463535	18650	2600 mAh	lamelle	4	8,09
491463536	18650	2000 mAh	piatto	4	5,70
491463537	18650	2600 mAh	lamelle	4	7,93
491463570	18650	3000 mAh	piatto	4	7,29
491463571	18650	3300 mAh	piatto	4	7,29
491463572	18650	3350 mAh	lamelle	4	8,13



adatte per sistemi anti intrusione, apparecchiature elettromedicali e fotografiche

BATTERIE AGLI IONI DI LITIO 3,2 V RICARICABILI CON CAVETTO E CONNETTORE

NOVITA' PRODOTTO

Batteria Li-FePO4
3,2V 0,5Ah 14500
con cavetto e connettore



Art. 491463560
€ 2,85 M.O.:10

NOVITA' PRODOTTO

Batteria Li-FePO4
3,2V 1,5Ah 18650
con cavetto e connettore



Art. 491463561
€ 3,60 M.O.:10

BATTERIE AGLI IONI DI LITIO 3,6 V RICARICABILI CON CAVETTO

NOVITA' PRODOTTO

Batteria ER14250 Li-Ion
3.6V 1200mAh
con cavetto



Art. 491463562
€ 6,04 M.O.:10

NOVITA' PRODOTTO

Batteria ER14505 Li-Ion
3.6V 2400mAh
con cavetto



Art. 491463563
€ 8,13 M.O.:10

NOVITA' PRODOTTO

Batteria ER14500 Li-Ion
3.6V 2200mAh
con cavetto e connettore 3 poli



Art. 491463565
€ 8,13 M.O.:10

Celle ricaricabili ad alte prestazioni, ideali per dispositivi anti intrusione e allarmi

scopri la nostra offerta di batterie al litio su
www.melchioni-ready.com

BATTERIE AL LITIO

BATTERIE AGLI IONI DI LITIO NON RICARICABILI

ARTICOLO	TIPO	TENSIONE	CAPACITÀ	TERMINALI	M.O.	PREZZO €
491463501	ER14250 1/2 AA	3,6 V	1200 mAh	reofori	5	5,23
491463503	ER14505 AA	3,6 V	2400 mAh	reofori	5	6,21
491463504	ER34615 D	3,6 V	19000 mAh	reofori	10	25,24
491463505	ER26500 C	3,6 V	9000 mAh	reofori	2	18,75
491463506	CR123A	3 V	1300 mAh	paglietta	5	5,25
491463555	CR123A	3 V	1500 mAh	reofori	10	2,47
491463508	ER14505 AA	3,6 V	2400 mAh	paglietta	10	6,89
491463509	ER34615 D	3,6 V	19000 mAh	paglietta	2	27,96
491463510	ER26500 C	3,6 V	9000 mAh	paglietta	2	19,03
491463511	ER14250 1/2 AA	3,6 V	1200 mAh	senza	10	5,21
491463512	ER14505 AA	3,6 V	2400 mAh	senza	5	7,07
491463540	17450	3 V	2200mah	senza	4	6,77



adatte per sistemi anti intrusione
apparecchiature elettromedicali
e fotografiche

BATTERIE ALCALINE E AL LITIO

Nuova gamma di batterie alcaline e al litio MKC: energia affidabile, sempre.

Progettate per offrire prestazioni durature e massima efficienza, le nuove batterie MKC sono la scelta ideale per alimentare i tuoi dispositivi quotidiani. Disponibili in tutti i formati più richiesti, garantiscono potenza costante, sicurezza e qualità, sia per l'uso domestico che professionale.

Con MKC, l'energia non si ferma mai!

BATTERIE ALCALINE

ARTICOLO	TIPO	FORMATO	TENSIONE	CAPACITÀ	DIMENSIONI	CONFEZIONE	M.O.	PREZZO €
491465600	AAA	LR03	1,5 V	1200 mAh	10,5 x 44	Blister 4pz	1	1,60
491465601	AAA	LR03	1,5 V	1200 mAh	10,5 x 44	Blister 8 pz	1	2,81
491465602	AAA	LR03	1,5 V	1200 mAh	10,5 x 44	Box 40 pz	1	11,29
491465603	AA	LR6	1,5 V	2800 mAh	14,5 x 50,5	Blister 4pz	1	1,60
491465604	AA	LR6	1,5 V	2800 mAh	14,5 x 50,5	Blister 8 pz	1	2,81
491465605	AA	LR6	1,5 V	2800 mAh	14,5 x 50,5	Box 40 pz	1	11,29
491465606	C	LR14	1,5 V	8500 mAh	26,2 x 50	Blister 2 pz	1	3,58
491465607	D	LR20	1,5 V	18500 mAh	34,2 x 61,5	Blister 2 pz	1	5,27
491465608	9V	6LR61	9 V	800 mAh	15,5 x 26,5 x 48,5	Blister 1 pz	1	2,25



BATTERIE AL LITIO

ARTICOLO	TIPO	TENSIONE	CAPACITÀ	DIMENSIONI	CONFEZIONE	M.O.	PREZZO €
491465609	123A	3 V	1600 mAh	17 x 34,5	Blister 1pz	1	2,06
491465610	CR2016	3 V	80 mAh	20 x 1,6	Blister 5 pz	1	2,81
491465611	CR2025	3 V	150 mAh	20 x 2,5	Blister 5 pz	1	2,81
491465612	CR2032	3 V	210 mAh	20 x 3,2	Blister 5 pz	1	2,81
491465613	CR2450	3 V	540 mAh	24,5 x 5	Blister 5 pz	1	5,46



BATTERIE AL LITIO



Batteria energizer AA
1,5V litio blister 2pcs

Art. 491466100
€ 10,24 M.O.: 12



Batteria energizer AAA
1,5V litio blister 2pcs

Art. 491466101
€ 10,37 M.O.: 12



BATTERIE ALCALINE

ENERGIZER KIT TATAMI

Espositore da banco
di batterie Energizer
96 AA, 36 AAA, 10 A23, 10 CR2032
confezionate in blister

Art. 491466170
€ 423,96 M.O.: 1



ENERGIZER Max Plus
batteria alcalina AA CHP4
in blister da 4 pile

Art. 491467404
€ 5,99 M.O.: 1



ENERGIZER Max Plus
batteria alcalina AAA CHP4
in blister da 4 pile

Art. 491467405
€ 5,84 M.O.: 1



ENERGIZER Max Plus
batteria alcalina C CHP2
in blister da 2 pile

Art. 491467406
€ 7,74 M.O.: 1

ENERGIZER Max Plus
batteria alcalina D CHP2
in blister da 2 pile

Art. 491467407
€ 8,20 M.O.: 1



ENERGIZER Max Plus
batteria alcalina 9V CHP1
in blister da 1 pila

Art. 491467408
€ 7,46 M.O.: 1

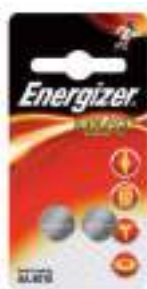

ARTICOLO	MPN	DESCRIZIONE	BLISTER	M.O.	PREZZO €
491466154	LR14	Energizer C alcalina LR14	2	12	8,14
491466127	A23	Energizer 608305 A23	1	10	2,08
491466124	LR1	Energizer E90 608306 LR1	1	10	3,37
491466135	CR123A	Energizer photo litio EL123AP	1	6	7,35
491466130	LR44	Energizer A76 - 623055 LR44	2	10	2,69

BATTERIE AL LITIO

GRUNDIG

BATTERIA AL LITIO 3V

Utilizzo: telecomandi, orologi, sveglie, giochi elettronici in blister da 5 pz (prezzo per blister)

ARTICOLO	FORMATO	DIMENSIONI	M.O.	PREZZO €
491466202	CR1216	20 x 1 mm	48	2,38
491466203	CR1620	20 x 1,6 mm	48	2,38
491466204	CR2016	20 x 1,6 mm	48	2,38
491466205	CR2025	20 x 2,5 mm	48	2,38
491466206	CR2032	20 x 3,2 mm	48	2,38
491466207	CR2430	30 x 2,45 mm	48	4,94
491466208	CR2450	50 x 2,45 mm	48	4,94



Batterie litio 3V a bottone in blister da 5 pz (prezzo per batteria)



ARTICOLO	MODELLO	M.O.	PREZZO €
491460712	CR2016	20	0,37
491460713	CR2025	5	0,37
491460714	CR2032	1	0,35

BATTERIE AL NI-MH



Batterie ricaricabili NI-Mh Stilo AA

ARTICOLO	CAPACITÀ	CONFEZIONE	M.O.	PREZZO €
491462192	2600 mAh	blister da 4	1	17,10
491462190			50	3,87
491462186	2400 mAh	bulk	10	4,48
491462221	3000 mAh		50	4,93



Batterie ricaricabili NI-Mh ministilo AAA



ARTICOLO	CAPACITÀ	CONFEZIONE	M.O.	PREZZO €
491462230	1000 mAh	blister da 4	1	8,99
491462231		bulk	50	2,28
491462195	900 mAh	blister da 4	1	8,54
491462193		bulk	50	1,94
491462179	850 mAh	blister da 4	1	8,04
491464098	550 mAh	bulk	10	1,51



Batterie ricaricabili NI-Mh terminali a lamelle in bulk

ARTICOLO	TIPO	CAPACITÀ	M.O.	PREZZO €
491462232	AAA	1000mAh	10	2,20
491462191	AA	2600 mAh	10	4,12
491464857		1600 mAh	50	3,15

Accumulatore NI-Mh tipo SC con terminali a lamelle in bulk



ARTICOLO	CAPACITÀ	M.O.	PREZZO €
491464898	3500 mAh	18	6,78
491462151	2400 mAh	10	5,86
491462896	2000 mAh	20	4,25



Batterie ricaricabili NI-Mh con terminali

NOVITA' PRODOTTO



ARTICOLO	TIPO	CAPACITÀ	M.O.	PREZZO €
491464801	1/2 A	1000 mAh	10	2,67
491464802	4/5 SC	2000 mAh	10	3,38
491464803	4/5 A	2000 mAh	10	3,54
491464804	4/5 AA	1200 mAh	10	2,67



BATTERIE AL NI-CD

Batteria NI-CD SC 2000mAh
con terminali a lamelle



Art. 491464896

€ 2,90 M.O.: 1

BATTERIE INDUSTRIALI DURACELL PROCELL

ARTICOLO	MPN	TIPO	M.O.	PREZZO €
812361300	BXBLR6/PC	AA Constant x10	10	0,86
812361305	BXBLR03/PC	AAA Constant x10	10	0,79
812361320	BXBLR20/PC	D Constant x10	10	3,22



PROCELL
INDUSTRIAL BATTERIES

Batterie Alkaline
Procell Constant
in confezione da 10pz



ARTICOLO	MPN	TIPO	M.O.	PREZZO €
812361350	BXBLR6/PI15	AA Intense 1.5 x 10	10	1,04
812361355	BXBLR03/PI15	AAA Intense 1.5 x 10	10	0,97
812361360	BXB6LR61/PI15	9V Intense 1.5 x 10	10	3,50
812361370	BXBLR20/PI15	D Intense 1.5 x 10	10	3,54

Batterie Alkaline
Procell Intense 1.5
in confezione da 10pz



BATTERIE DURACELL ALKALINE E LITIO

ARTICOLO	MPN	TIPO	Q.TÀ / CONF	M.O.	PREZZO €
812355280	DU0101	AA	4	1	5,15
812355285	DU0201	AAA	4	1	5,15
812361620	DU0141	AA	6	1	5,42
812361625	DU0241	AAA	6	1	5,42
812355290	DU0301	C	2	1	4,77
812355300	DU0503	9V	1	1	4,77
812355295	DU0401	D	2	1	6,96

Batterie Alkaline
Duracell PLUS in blister

DURACELL



Batterie Alkaline Duracell specialistiche in blister

Le batterie "specialistiche" sono progettate appositamente per applicazioni specializzate come i dispositivi di sicurezza e medicali, fotocamere digitali, orologi e apparecchi elettronici che necessitano di batterie più piccole o di pile a bottone.

Duracell MN2500 AAAA
in blister da 2 pile

Art. 810655645

€ 3,92 M.O.: 1



Batterie al Litio Duracell electronics in blister

ARTICOLO	MPN	TIPO	Q.TÀ / CONF	M.O.	PREZZO €
810445200	DU21B2	CR2025	2	1	3,56
810445195	DU22B2	CR2032	2	1	3,56
810445205	DU30	1220	1	1	2,88
810445210	DU48	1616	1	1	2,42
810445215	DU27	1620	1	1	2,42
810445230	DU31	2450	1	1	3,48
810655585	DU23	LR44	2	1	2,00



Batteria Alkalina AAA 1,5V
Dim: ø 10.5 x 44.5 mm



ARTICOLO	MODELLO	CONFEZIONE	M.O.	PREZZO €
491468500	LR03-4PK	blister 4	1	2,17
491468507	LR03-4PK	shrink 4	1	2,03
491468509	LR03-10PK	blister 10	1	5,71
491468510	LR03-32PK	shrink 32	1	16,78



Batteria Alkalina AA 1,5V
Dim: ø 14.5 x 50.5 mm



ARTICOLO	MODELLO	CONFEZIONE	M.O.	PREZZO €
491468501	LR06-4PK	blister 4	1	2,17
491468506	LR06-4PK	shrink 4	1	2,03
491468508	LR06-10PK	blister 10	1	5,71
491468511	LR06-32PK	shrink 32	1	16,78



Art. 491468512
€ 2,71 M.O.: 1

LR03 SUPER-4PK
Batteria Super Alkalina AAA 1,5V
Blister 4 pz
Dim: ø 10.5 x 44.5 mm



Art. 491468513
€ 2,71 M.O.: 1

LR06 SUPER-4PK
Batteria Super Alkalina AA 1,5V
Blister 4 pz
Dim: ø 14.5 x 50.5 mm



Batteria Alkalina D 1,5V
Dim: ø 34.2 x 61.5 mm

ARTICOLO	MODELLO	CONF	M.O.	PREZZO €
491468503	LR20-2PK	blister 2	1	5,82
491468505	LR20-2PK	shrink 2	5	5,43



ARTICOLO	MODELLO	TIPO	CONFEZIONE	M.O.	PREZZO €
491468502	6LR61-1PK	9V	blister 1	1	2,47
491468504	LR14-2PK	C 1,5V	blister 2	1	3,54
491468514	LR01-1PK	N 1,5V	blister 1	1	2,17



maxell



Art. 491468523
€ 2,28 M.O.: 1

Batteria ZN/C 9V
 Modello: 6F22-1PK
 Conf: blister 1 pz
 Dim: 26.5 x 17.5 x 48.5 mm



Batteria ZN/C D 1,5V
 Modello: R20-2PK
 Dim: ø 34.2 x 61.5 mm

ARTICOLO	CONFEZIONE	M.O.	PREZZO €
491468524	blister 2	1	2,56
491468525	shrink 2	1	2,47



Batteria ZN/C C 1,5V
 Modello: R14-2PK
 Dim: ø 26.2 x 50 mm

ARTICOLO	CONFEZIONE	M.O.	PREZZO €
491468526	blister 2	1	1,95
491468527	shrink 2	1	1,68



Batteria ZN/C AA 1,5V
 Modello: R6-4PK
 Dim: ø 14.5 x 50.5 mm

ARTICOLO	CONFEZIONE	M.O.	PREZZO €
491468528	blister 4	1	1,75
491468529	shrink 4	1	1,47



Batteria ZN/C AAA 1,5V
 Modello: R03-4PK
 Dim: ø 10.5 x 44.5 mm

ARTICOLO	CONFEZIONE	M.O.	PREZZO €
491468530	blister 4	1	1,95
491468531	shrink 4	1	1,95

BATTERIE BOTTONE

Batterie Alcaline 1,5V in blister da 5 x 2 pz

ARTICOLO	TIPO	DIMENSIONE	Q.TÀ	M.O.	PREZZO €
491468515	LR41	ø 7,9 x 3,6 mm	10	1	4,54
491468516	LR43	ø 11,6 x 4,2 mm	10	1	4,85
491468517	LR44	ø 11,6 x 5,4 mm	10	1	4,46
491468518	LR1130	ø 11,6 x 3,1 mm	10	1	4,15



Batterie al Litio 3V in blister da 1 o 5 pz

ARTICOLO	MODELLO	DIMENSIONE	Q.TÀ	M.O.	PREZZO €
491468541	CR1220-1Pc	ø 12.5 x 20 mm	1	1	1,16
491468542	CR1616-1Pc	ø 16 x 16 mm	1	1	1,16
491468543	CR1620-1Pc	ø 16 x 20 mm	1	1	1,95
491468544	CR2032-1Pc	ø 20 x 32 mm	1	1	1,01
491468545	CR1216-1Pc	ø 12.5 x 16 mm	1	1	1,16
491468546	CR2016-1Pc	ø 20 x 16 mm	1	1	1,18
491468547	CR2025-1Pc	ø 20 x 25 mm	1	1	1,18
491468548	CR2016-5PK	ø 20 x 16 mm	5	1	5,43
491468549	CR2025-5PK	ø 20 x 25 mm	5	1	5,43
491468550	CR2032-5PK	ø 20 x 32 mm	5	1	5,43



BATTERIE ALL'OSSIDO D'ARGENTO

maxell



ARTICOLO	MODELLO	TIPO	DIMENSIONI	M.O.	PREZZO €
491468561	SR44W-1PC	357	5.4 x Ø 11.6 mm	10	3,94
491468562	SR44SW-1PC	303	5.4 x Ø 11.6 mm	10	3,94
491468563	SR43W-1PC	386	4.2 x Ø 11.6 mm	10	4,40
491468564	SR43SW-1PC	301	1.7 x Ø 11.6 mm	10	4,35
491468565	SR-1136SW-1PC	344	3.6 x Ø 11.6 mm	10	7,42
491468566	SR1130W-1PC	389	3.1 x Ø 11.6 mm	10	2,98
491468567	SR-1130SW-1PC	390	3.1 x Ø 11.6 mm	10	2,98
491468568	SR1120W-1PC	391	2.15 x Ø 11.6 mm	10	2,73
491468569	SR-1120SW-1PC	381	0.89 x Ø 11.6 mm	10	3,04
491468570	SR-1116SW-1PC	366	1.6 x Ø 11.6 mm	10	3,15
491468571	SR-936SW-1PC	394	3.65 x Ø 9.5 mm	10	2,63
491468572	SR936W-1PC	380	3.6 x Ø 9.5 mm	10	5,12
491468573	SR927W-1PC	399	2.65 x Ø 9.5 mm	10	2,14
491468574	SR-927SW-1PC	395	0.78 x Ø 9.5 mm	10	1,75
491468575	SR920W-1PC	370	2.15 x Ø 9.5 mm	10	1,86
491468576	SR-920SW-1PC	371	2.15 x Ø 9.5 mm	10	1,25
491468577	SR916W-1PC	372	2.15 x Ø 6.8 mm	10	2,95
491468578	SR-916SW-1PC	373	1.65 x Ø 9.5 mm	10	1,93
491468579	SR41W-1PC	392	3.6 x Ø 7.9 mm	10	1,99
491468580	SR41SW-1PC	384	0.71 x Ø 7.9 mm	10	1,99

ARTICOLO	MODELLO	TIPO	DIMENSIONI	M.O.	PREZZO €
491468581	SR731SW-1PC	329	3.1 x Ø 7.9 mm	10	2,43
491468582	SR726W-1PC	396	2.65 x Ø 7.9 mm	10	1,82
491468583	SR726SW-1PC	397	2.65 x Ø 7.9 mm	10	1,82
491468584	SR721W-1PC	361	2.1 x Ø 7.9 mm	10	1,77
491468585	SR721SW-1PC	362	0.41 x Ø 7.9 mm	10	1,42
491468586	SR716W-1PC	314	2.15 x Ø 6.8 mm	10	2,6
491468587	SR716SW-1PC	315	1.65 x Ø 7.9 mm	10	1,71
491468588	SR712SW-1PC	346	1.29 x Ø 7.9 mm	10	2,19
491468589	SR626W-1PC	376	2.6 x Ø 6.8 mm	10	1,71
491468590	SR626SW-1PC	377	0.39 x Ø 6.8 mm	10	0,77
491468591	SR621W-1PC	363	2.1 x Ø 6.8 mm	10	2,06
491468592	SR621SW-1PC	364	0.31 x Ø 6.8 mm	10	0,74
491468593	SR616SW-1PC	321	0.25 x Ø 6.8 mm	10	1,18
491468594	SR527SW-1PC	319	2.7 x Ø 5.8 mm	10	1,51
491468595	SR521SW-1PC	379	0.24 x Ø 5.8 mm	10	0,94
491468596	SR516SW-1PC	317	0.18 x Ø 5.8 mm	10	1,47
491468597	SR512SW-1PC	335	1.25 x Ø 5.8 mm	10	1,82
491468598	SR421SW-1PC	348	2.5 x Ø 4.8 mm	10	3,35
491468599	SR416SW-1PC	337	1.65 x Ø 4.8 mm	10	2,93
491468600	SR1116W-1PC	365	1.65 x Ø 11.6 mm	10	2,95

CARICABATTERIE E TESTER

MKC-1292 Carica/scarica batterie Ni-Mh/Ni-CD AA/AAA/2x9V
Art. 491929271

€ 16,79 M.O.: 1



Caricabatteria per batterie al Ni-Cd/Mh e al litio

Art. 491929220

€ 19,71 M.O.: 1



Caricabatteria per batterie Ni-Cd/Mh con presa USB

Art. 491929023

€ 10,36 M.O.: 1



Prova batterie universale batterie 9V, cilindriche, a bottone

Art. 493933100

€ 9,63 M.O.: 1



Prova batterie universale per batterie a bottone, AA/AAA/C/D/9V

Art. 493933102

€ 6,91 M.O.: 1

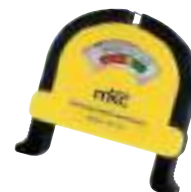

ALIMENTATORI SLIM CON MORSETTO A TENSIONE COSTANTE

ideali per illuminazione LED e videosorveglianza



CARATTERISTICHE TECNICHE

Dimensioni ridotte, versione Slim
 Protezione vs sovraccarichi / cortocircuiti
 Tensione di ingresso: 180-240 Vca
 Frequenza: 50/60 Hz
 Protezione termica
 Efficienza: > 85%
 PFC: > 0.6
 Temperatura di lavoro: -20/45 °C
 Connessione: Morsetti a vite
 Contenitore: Metallico in alluminio
 Grado di protezione: IP20
 Raffreddamento passivo
 Elevata efficienza e peso e volume ridotti

ARTICOLO	MODELLO	TENSIONE DI USCITA (VDC)	CARICO MAX (W)	CORRENTE MAX (A)	DIMENSIONI LXPXH (MM)	M.O.	PREZZO €
530137040	MKC-S-60W-12	12	60	5	160 x 39 x 30	1	16,95
530137041	MKC-S-60W-24	24	60	2,5	160 x 39 x 30	1	16,95
530137042	MKC-S-100W-12	12	100	8,3	188 x 47 x 35	1	23,39
530137043	MKC-S-100W-24	24	100	4,15	188 x 47 x 35	1	23,39
530137044	MKC-S-150W-12	12	150	12,5	200 x 59 x 39	1	29,83
530137045	MKC-S-150W-24	24	150	6,25	200 x 59 x 39	1	29,83
530137046	MKC-S-200W-12	12	200	16,7	223 x 68 x 40	1	34,12
530137047	MKC-S-200W-24	24	200	8,35	223 x 68 x 40	1	34,12
530137048	MKC-S-250W-12	12	250	21	223 x 68 x 40	1	52,58
530137049	MKC-S-250W-24	24	250	10,5	223 x 68 x 40	1	52,58

ALIMENTATORI CON MORSETTO A TENSIONE COSTANTE

ideali per illuminazione LED e videosorveglianza

CARATTERISTICHE TECNICHE

Protezione contro i sovraccarichi
 Protezione contro i cortocircuiti
 Protezione termica
 Protezione in ingresso 1.5KV
 PFC: > 0.7
 Efficienza >80 %
 ADJ: Trimmer per la regolazione della tensione in uscita +- 10%

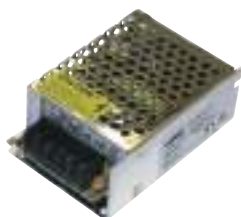

ARTICOLO	MODELLO	TENSIONE DI USCITA (VDC)	CARICO MAX (W)	CORRENTE MAX (A)	DIMENSIONI LXPXH (MM)	M.O.	PREZZO €
530137000	MKC25-12IM	12	25	2	85 x 58 x 33	1	12,02
530137001	MKC25-24IM	24	25	1	85 x 58 x 33	1	12,02
530137002	MKC36-12IM	12	36	3	110 x 78 x 38	1	15,24
530137003	MKC36-24IM	24	36	1,5	110 x 78 x 38	1	15,24
530137004	MKC60-12IM	12	60	5	110 x 78 x 38	1	17,60
530137005	MKC60-24IM	24	60	2,5	110 x 78 x 38	1	17,60
530137006	MKC100-12IM	12	100	8,5	160 x 98 x 42	1	21,89
530137007	MKC100-24IM	24	100	4,25	160 x 98 x 42	1	21,89
530137008	MKC150-12IM	12	150	12,5	198 x 98 x 42	1	28,33
530137009	MKC150-24IM	24	150	6,25	198 x 98 x 42	1	28,33
530137010	MKC200-12IM	12	200	16,5	198 x 98 x 92	1	33,91
530137011	MKC200-24IM	24	200	8,25	198 x 98 x 92	1	33,91
530137012	MKC250-12IM	12	250	21	199 x 110 x 50	1	50,43
530137013	MKC250-24IM	24	250	10,5	199 x 110 x 50	1	50,43
530137014	MKC360-12IM	12	360	30	215 x 115 x 50	1	65,46
530137015	MKC360-24IM	24	360	15	215 x 115 x 50	1	65,46

SERIE IP67



530137018	MKC10-12	12	10	0.83	90 x 30 x 20	1	12,92
530137019	MKC10-24	24	10	0.42	90 x 30 x 20	1	13,31
530137020	MKC20-12	12	20	1.66	160 x 30 x 20	1	18,24
530137021	MKC20-24	24	20	0.83	160 x 30 x 20	1	18,24
530137022	MKC30-12	12	30	2.5	200 x 30 x 20	1	22,32
530137023	MKC30-24	24	30	1.25	200 x 30 x 20	1	22,32
530137024	MKC60-12	12	60	5	150 x 50 x 30	1	42,70
530137025	MKC60-24	24	60	2.5	150 x 50 x 30	1	42,70
530137026	MKC100-12	12	100	8.33	180 x 70 x 40	1	74,04
530137027	MKC100-24	24	100	4.16	180 x 70 x 40	1	74,04
530137028	MKC150-12	12	150	12.5	210 x 70 x 40	1	98,50
530137029	MKC150-24	24	150	6.25	210 x 70 x 40	1	98,50
530137030	MKC200-12	12	200	16.66	205 x 125 x 45	1	118,03
530137031	MKC200-24	24	200	8.33	205 x 125 x 45	1	118,03
530137032	MKC240-12	12	240	20	205 x 125 x 45	1	128,75
530137033	MKC240-24	24	240	10	205 x 125 x 45	1	128,75

ALIMENTATORI A TENSIONE COSTANTE

Alimentatori switching 12/24V 3W
Ingresso 100-240Vca IP20
Non Dimmerabile

Ideale per illuminazione a LED e videosorveglianza

ARTICOLO	TENSIONE	M.O.	PREZZO €
530137055	12 V	1	6,42
530137056	24 V	1	6,42

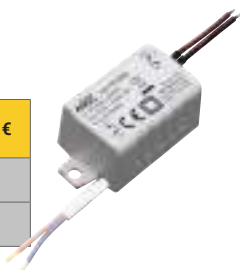

Alimentatori switching 12/24V 6W
Ingresso 100-240Vca IP20
Non Dimmerabile

Ideale per illuminazione a LED e videosorveglianza

ARTICOLO	TENSIONE	M.O.	PREZZO €
530137057	12 V	1	6,87
530137058	24 V	1	6,87



melchioni
mc

ALIMENTATORI CON MORSETTO A TENSIONE COSTANTE



Alimentatori di sicurezza in modalità switching a uscita singola con ingresso c.a. con funzione di carica batterie

I campi di impiego di questi alimentatori includono sistemi di sicurezza sistemi di controllo degli accessi sistemi di illuminazione d'emergenza sistemi di allarme sistemi di monitoraggio centrali



ARTICOLO	MPN	POTENZA	TENSIONE	M.O.	PREZZO €
530136930	SCP-35-12	35W	12V	1	35,88
530136931	SCP-35-24		24V	1	36,73
530136932	SCP-50-12	50W	12V	1	41,46
530136933	SCP-50-24		24V	1	46,88
530136934	SCP-75-12	75W	12V	1	54,17
530136935	SCP-75-24		24V	1	60,42

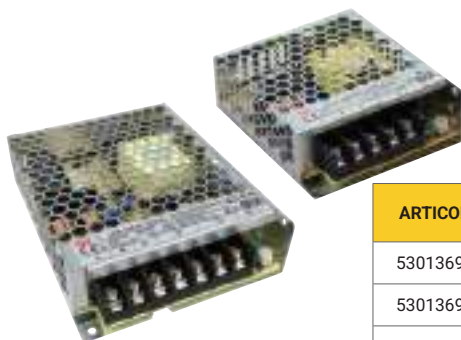

Alimentatori switching Meanwell

Ingresso voltaggio 85-264vca
Temperature di esercizio: -30°+70°
Contenitore metallico forato
Connessione a morsetto a vite
Grado di protezione IP20

I campi di impiego di questi alimentatori switching includono sistemi di illuminazione, impianti industriali, macchine di produzione, illuminazione, videosorveglianza



ARTICOLO	MPN	POTENZA	TENSIONE	INTENSITÀ	DIMENSIONE	M.O.	PREZZO €
530136980	LRS-35-12	35W	12V	3A	99 x 82 x 30 mm	9,03 €	20,82
530136981	LRS-35-24		24V	1,5A		8,32 €	19,21
530136982	LRS-50-12	50W	12V	4,2A	99 x 82 x 30 mm	9,72 €	22,44
530136983	LRS-50-24		24V	2,4A		9,15 €	26,44
530136984	LRS-75-12	75W	12V	6A	99 x 97 x 30 mm	11,61 €	26,80
530136985	LRS-75-24		24V	3,2A		12,19 €	28,13
530136986	LRS-100-12	100W	12V	8,5A	159 x 97 x 30 mm	13,06 €	30,16
530136987	LRS-100-24		24V	4,5A		12,28 €	28,36
530136988	LRS-150-12	150W	12V	12,5A	159 x 97 x 30 mm	16,19 €	37,38
530136989	LRS-150-24		24V	6,5A		15,13 €	34,92

ALIMENTATORI PER LED SERIE LPV

Tensioni in ingresso: 90~264VAC
Frequenza: 47~63 Hz
Temperatura di lavoro: -30~+75°C
Classe di isolamento IP67

Protezione sovraccarico, superamento della tensione di alimentazione, protezioni ai cortocircuiti.
Prodotti consigliati per l'utilizzo con:
strisce LED, display LED, luce LED decorativo / architettonale



NOVITA' PRODOTTO



ARTICOLO	MPN	POTENZA	TENSIONE	INTENSITÀ	DIMENSIONE MM	M.O.	PREZZO €
499045200	LPV-20-12	20 W	12 V	1,67 A	35 x 118 x 26	1	20,09
499045201	LPV-35-12	36 W		3 A	40 x 148 x 30	1	27,43
499045202	LPV-60-12	60 W		5 A	42,5 x 162,5 x 32	1	30,04
499045203	LPV-100-12	100 W		8,5 A	52 x 190 x 37	1	49,21
499045204	LPV-35-24	35 W	24 V	1,5 A	40 x 148 x 30	1	27,43
499045207	LPV-60-24	60 W		2,5 A	42,5 x 162,5 x 32	1	30,27



CONVERTITORI MONOFASE



Ingresso CA universale / gamma completa
 Protezione: cortocircuito, sovraccarico,
 sovratensione, sovratemperatura
 Raffreddamento per convezione ad aria libera
 Possono essere installati su guida DIN TS-35/7,5 o 15

Adatti per sistema di controllo industriale
 Apparecchiature per la produzione
 di semiconduttori
 Automazione di fabbrica
 Apparecchiature elettromeccaniche



ARTICOLO	MPN	POTENZA	TENSIONE	INTENSITÀ	DIMENSIONE MM	M.O.	PREZZO €
530136922	NDR-75-24	76,8 W	24 V	3,2 A	32 x 125,2 x 102	1	45,83
530136939	NDR-120-24	120 W	24 V	5 A	40 x 125,2 x 113,5	1	89,10
530136925	NDR-240-24	240 W	24 V	10 A	63 x 125,2 x 113,5	1	107,81
530136917	NDR-480-24	480 W	24 V	20 A	85,5 x 125,2 x 128,5	1	197,92

REGOLATORI DI TENSIONE

Il regolatore di tensione (in inglese Automatic Voltage Regulator o AVR) è un dispositivo elettronico in grado di regolare automaticamente la tensione ed eventualmente anche la frequenza secondo i valori impostati, i quali in alcuni casi possono essere variati mentre in altri sono vincolati dalle caratteristiche tecniche dell'apparecchio.

Applicazioni

Nei sistemi basati sul deviatore di corrente o shunt, tramite un regolatore di tensione si converte la corrente alternata (con frequenza e tensione variabile nel tempo) in corrente continua a tensione costante. Essi trovano impiego nei generatori sincroni di ultima generazione. Altre applicazioni riguardano la stabilizzazione di tensioni continue in valori più bassi, come nel caso per esempio dei circuiti di alimentazione per schede elettroniche.



ARTICOLO	DESCRIZIONE	MAX USCITA KVA	TENSIONE INGRESSO	TENSIONE USCITA	CORRENTE MAX USCITA	DIMENSIONI (W * D * L) MM	M.O.	PREZZO €
491929050	Regolatore di tensione monofase 0,5 Kw	0.5	220V	0-250V	2	125 x 150 x 130	1	71,17
491929051	Regolatore di tensione monofase 1 Kw	1.0			4	180 x 200 x 210	1	111,85
491929052	Regolatore di tensione monofase 3 Kw	3.0			12	210 x 230 x 235	1	201,31

STABILIZZATORI MONOFASE

Stabilizzatori di tensione dotati di tecnologia servoassistita a controllo elettronico con microprocessore

Caratteristiche principali

- Utenze domestiche, sistemi di illuminazione, processi industriali, telecomunicazioni, elettromedicali
- Elevata velocità di stabilizzazione
- Alto rendimento
- Stabilizzazione senza microinterruzioni
- Non introduce distorsioni armoniche
- Gestione variazioni da 0 al 100% del carico
- Display multifunzione con visualizzazione ed impostazione dei parametri di funzionamento

Ingresso

Numero di fasi: 1F+N
 Tensione nominale: 220/230/240Vac (selezionabile)
 Tolleranza tensione d'ingresso: 160Vac - 270Vac
 Frequenza nominale: 50/60 Hz

Condizioni ambientali operative

Temperatura di lavoro: Da 0 a 55 °C
 Umidità relativa: < 95% non condensata
 Altitudine massima: 3000 m
 Grado di protezione: IP20
 Certificazioni: CE

Uscita

Numero di fasi: 1F+N
 Tensione nominale: 220/230/240Vac (selezionabile)
 Stabilità tensione: ±1%
 Velocità di regolazione: mSec/Volt
 Rendimento: >97%
 Variazione del carico: Da 0% a 100%
 Sovraccarico: 150%
 Frequenza nominale: 50/60 Hz



ARTICOLO	MODELLO	POTENZA NOMINALE / ATTIVA	FATTORE DI POTENZA	DIMENSIONI (L * H * P)	PESO	M.O.	PREZZO €
491929457	FSTESM4K5M	4,5 KVA / 3,6 KW	0,8	30 x 34 x 40 cm	20 kg	1	1.128,13
491929458	FSTESM10KM	10 KVA / 8 KW			36 kg	1	1.955,42

ALIMENTATORI USB MKC

Con un'uscita reale di **20/35/45/65/140W**, è possibile caricare qualsiasi telefono cellulare, tablet e altri dispositivi USB.

Sicurezza garantita

I materiali pregiati e i dispositivi di sicurezza integrati proteggono voi e il vostro dispositivo da cortocircuiti e sovratensioni.

Chip intelligente

Controlla la sovratemperatura, la sovracorrente, il sovraccarico e il cortocircuito.



Caricatore USB 45W
GAN PD fast charge
1 USB-C + 1 USB-A

Art. 491929604
€ 19,79 M.O.: 1



Caricatore USB 20W
GAN PD fast charge
1 USB-C + 1 USB-A

Art. 491929600
Art. 491929601
€ 10,31 M.O.: 1



Caricatore USB 35W
GAN PD fast charge
1 USB-C + 1 USB-A

Art. 491929602
Art. 491929603
€ 12,81 M.O.: 1



Caricatore USB 65W
GAN PD fast charge
2 USB-C + 1 USB-A

Art. 491929605
€ 26,04 M.O.: 1



Caricatore USB 140W
GAN PD fast charge
3 USB-C + 1 USB-A

Art. 491929606
€ 62,29 M.O.: 1

GAMMA CAVI USB 100W



Caratteristiche

- Materiale: Rame
- Guaina: PVC
- Colore: nero
- Confezione: sacchetto appendibile



ARTICOLO	MODELLO	CONNETTORE	POTENZA	VELOCITÀ	TIPO USB	LUNGHEZZA	M.O.	PREZZO €
486611200	MK-20.100.AC.05	A - C	100 W	480 Mbps	2.0	0,5 mt	1	2,26
486611201	MK-20.100.AC.1					1 mt	1	2,84
486611202	MK-20.100.AC.2					2 mt	1	4,30
486611203	MK-20.100.AC.4					4 mt	1	7,95
486611204	MK-20.100.CC.05	C - C		5 Gbps	3.0	0,5 mt	1	2,26
486611205	MK-20.100.CC.1					1 mt	1	2,84
486611206	MK-20.100.CC.2					2 mt	1	4,30
486611207	MK-20.100.CC.4					4 mt	1	8,38
486611208	MK-30.100.CC.05	C - C	10 Gbps	3.1	0,5 mt	1	6,53	
486611209	MK-30.100.CC.1				1 mt	1	7,14	
486611210	MK-30.100.CC.2				2 mt	1	8,38	
486611211	MK-30.100.CC.4				4 mt	1	13,06	
486611212	MK-31.100.CC.05	C - C	10 Gbps	3.1	0,5 mt	1	7,34	
486611213	MK-31.100.CC.1				1 mt	1	8,56	
486611214	MK-31.100.CC.2				2 mt	1	11,81	
486611215	MK-31.100.CC.4				4 mt	1	16,11	



CAVI USB

Cavo USB 2.0 in Alluminio ramato (CCA), Connettori: spina A / spina A, Nero



ARTICOLO	MPN	LUNGHEZZA MT	CONFEZIONE	M.O.	PREZZO €
486611153	3102/3M	3	bulk	6	2,45
486611154	3102/5M	5		6	4,46
486611168	3102B/1.5M	1.5	blister	6	2,03
486611169	3102B/3M	3		6	2,48
486611170	3102B/5M	5		3	3,45

Cavi USB 3.0 in Rame (CU), Connettori: spina A / spina A, Nero



ARTICOLO	MPN	LUNGHEZZA MT	CONFEZIONE	M.O.	PREZZO €
486611156	4102/3M	3 mt	bulk	3	6,42
486611157	4102/5M	5 mt		3	7,86
486611171	4102B/1.5M	1.5 mt	blister	3	4,87
486611172	4102B/3M	3 mt		3	7,14
486611173	4102B/5M	5 mt		3	8,67

Cavi USB 2.0 in Alluminio ramato (CCA), Connettori: prolunga spina A / presa A, Nero



ARTICOLO	MPN	LUNGHEZZA MT	CONFEZIONE	M.O.	PREZZO €
486611159	3103/3M	3 mt	bulk	6	4,97
486611176	3103B/5M	5 mt	blister	3	4,48

Cavi USB 2.0 in Alluminio ramato (CCA), Connettori: spina A / spina microB, Nero



ARTICOLO	MPN	LUNGHEZZA MT	CONFEZIONE	M.O.	PREZZO €
486611163	3107X/1M	1 mt	bulk	9	2,48
486611164	3107X/1.8M	1.8 mt		9	3,09
486611179	3107XB/1M	1 mt	blister	6	2,77
486611180	3107XB/1.8M	1.8 mt		6	7,12

Cavi USB 2.0 in Alluminio ramato (CCA), Connettori: spina A / spina B, Nero



ARTICOLO	MPN	LUNGHEZZA MT	CONFEZIONE	M.O.	PREZZO €
486611161	3101/2M	2 mt	bulk	6	3,32
486611178	3101B/3M	3 mt	blister	6	2,77

Cavi USB 2.0 in Alluminio ramato (CCA), Connettori: spina A / spina mini 5P, Nero



ARTICOLO	MPN	LUNGHEZZA MT	CONFEZIONE	M.O.	PREZZO €
486611166	3106/1.8M	1.8 mt	bulk	9	2,86
486611182	3106B/1.8M		blister	6	5,03

ALIMENTATORI A TENSIONE FISSA



Alimentatore
12V 1.5A IP67

Art. 491929229
€ 9,89 M.O.:1



Alimentatore
12V IP67
con connettore
5,5x2,1 mm

ARTICOLO	CORRENTE D'USCITA	M.O.	PREZZO €
491929227	1 A	1	9,89
491929230	1.5 A	1	10,40

NOVITA' PRODOTTO



Alimentatore 12V 2A
plug 5,5*2,1 mm

Art. 491929226
€ 9,75 M.O.:1



ALIMENTATORE 12 V

ARTICOLO	MODELLO	CORRENTE D'USCITA	PLUG	M.O.	PREZZO €
491929225	MKC1210AL	1 A	5.5*2.1 mm	1	7,73
491929217	MKC-02B	1.5 A	5.5*2.1 mm 5.5*2.5 mm	1	9,15



ALIMENTATORE 12 V CON SPINA

ARTICOLO	CORRENTE D'USCITA	PLUG	M.O.	PREZZO €
491929290	3 A	5.5*2.1 mm	1	16,77
491929291	5 A	5.5*2.5 mm	1	20,12
491929292	7 A	5.5*2.5 mm	1	25,21



Alimentatore 12V 5A
4 canali indipendenti

Uscite regolabili da 11-15V,
fino a 2A per canale
Connessione a morsetto, IP54
Ideale per videosorveglianza



Art. 491929298
€ 22,03 M.O.:1

ALIMENTATORI MULTITENSIONE



Alimentatore universale
3-12V switching, n.6 plug

ARTICOLO	POTENZA	INTENSITÀ	M.O.	PREZZO €
491929015	7,2 W	600 MAh	1	10,82
491929026	12 W	1 A	1	12,01



Alimentatore switching
universale 3-12V, n.6 plug

ARTICOLO	POTENZA	M.O.	PREZZO €
491929296	1500 MAh	1	16,90
491929297	2250 MAh	1	19,33



Alimentatore switching
20W 2.5A 2V n. 7 plug

Art. 491929188
€ 23,77 M.O.:1



Alimentatore switching
30W 1.5A 9-24V n. 7
plug

Art. 491929187
€ 21,74 M.O.:1



Alimentatore universale
per notebook
Selezione tensione automatica
con uscita USB 5VDC 90W 8A

Art. 491929449
€ 44,74 M.O.:1

Alimentatore MKC90 SLC
12/20VDC 90W con selettore
notebook n.8 plug

Art. 491929451
€ 31,52 M.O.:1



Alimentatore universale
per notebook 95W TOGETHER ON
10 connettori, compatibile con HP,
Lenovo, Dell, Asus, Acer, Samsung
Tensione di uscita a selezione automatica

Art. 491929455
€ 55,81 M.O.:1



ALIMENTATORI PER AMPLIFICATORI D'ANTENNA



Alimentatore slim MKC-12TV-F
CatV 12Vdc 450mAh
spinotti ingresso/uscita tipo F
dimensioni ridotte: 64x36x25,5mm

Art. 559578391
€ 11,20 M.O.:1



Alimentatore slim MKC-12TV-2F
CatV 12Vdc 450mAh
spinotti 1 ingresso/2 uscite tipo F
dimensioni ridotte: 64x36x25,5mm

Art. 559578392
€ 11,58 M.O.:1



**Silent inverter
Generator 2200VA
recoilstarting system**

- Generatore ad Inverter silenziato portatile e compatto
- Sistema Eco Speed Control per l'ottimizzazione dei consumi e la riduzione del rumore
- Motore OHV a 4 tempi, doppia uscita AC e DC 12
- Generazione tensione d'uscita sinusoidale
- Serbatoio per carburante con capacità per 10 ore al 50% del carico



Art. 491929486

€ 1.761,46 M.O.: 1

**Gasoline generator 3200VA
recoil starting system**

- Motore OHV a 4 tempi
- Serbatoio metallico per carburante con capacità per 10 ore al 50% del carico
- Allarme livello olio
- AVR e protezione da sovraccarico
- Caricabatteria
- Doppia uscita AC e DC 12V
- Bassa rumorosità



Art. 491929459

€ 979,69 M.O.: 1

**Gasoline generator 4200VA
electrical starting system**

- Motore OHV a 4 tempi
- Serbatoio metallico per carburante con capacità per 10 ore al 50% del carico
- Allarme livello olio
- AVR e protezione da sovraccarico
- Predisposto per Gasoline Generator ATS esterno
- Doppia uscita AC e DC 12V
- Bassa rumorosità



Art. 491929485

€ 1.236,98 M.O.: 1

**Gasoline Generator 7800VA
sistema di avviamento elettrico**

- Motore OHV a 4 tempi
- Serbatoio metallico per carburante con capacità per 10 ore al 50% del carico
- Allarme livello olio
- AVR e protezione da sovraccarico
- Doppia uscita AC e DC 12V
- Bassa rumorosità



Art. 491929420

€ 2.597,66 M.O.: 1

**Gasoline Generator 9200VA
sistema di avviamento elettrico/automatico**

- Motore OHV a 4 tempi
- Serbatoio metallico per carburante con capacità per 10 ore al 50% del carico
- Allarme livello olio
- AVR e protezione da sovraccarico
- Predisposto per Gasoline Generator ATS esterno
- Doppia uscita AC e DC 12V
- Bassa rumorosità



Art. 491929421

€ 3.117,19 M.O.: 1

ATS per 9200EA

L'ATS controlla la rete elettrica e ricarica la batteria del generatore. In caso di blackout, avvia automaticamente il motore del generatore e alimenta i dispositivi connessi. Quando il blackout è terminato, l'ATS alimenta nuovamente tramite la rete elettrica i dispositivi connessi, carica la batteria del generatore e spegne, successivamente, il motore del generatore.



Art. 491929422

€ 561,09 M.O.: 1

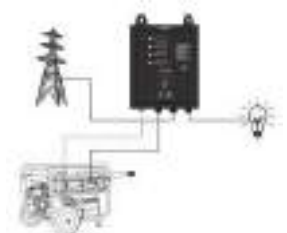

NUOVA SERIE INVERTER ONDA MODIFICATA E PURA MKC

La nuova serie di inverter MKC RS ad onda modificata e MKC RSP ad onda pura è disponibile nelle versioni 12V e 24V, con potenze da 150W fino a 3.000W, offrendo una soluzione affidabile ed efficiente per le applicazioni standard.

Tutti i modelli ad onda pura sono dotati della **funzione di priorità selezionabile**, che consente il passaggio automatico alla rete elettrica quando il camper è collegato ad essa, garantendo **continuità e sicurezza di alimentazione** anche per le utenze più sensibili. Tutti i modelli presentano un **cabinet ribassato**, progettato per facilitare l'installazione su mezzi mobili come camper e caravan.

Gli inverter con potenza uguale o superiore a 1.500W sono forniti di **telecomando di controllo**, incluso nella dotazione o disponibile come accessorio acquistabile separatamente.

CARATTERISTICHE TECNICHE

- Funzione By-pass automatico sulla rete elettrica (solo onda Pura)
- Priorità selezionabile tra rete elettrica/batterie (solo onda Pura)
- Connessioni bassa tensione ad alta resistenza
- Protezione da sovra-alimentazione e sotto-alimentazione
- Protezione da surriscaldamento e inversione di polarità
- Sistema protezione delle batterie
- Compatibile con batterie Pb++ e LiFePO4
- Ventilazione forzata controllata termicamente
- Cabinet ribassato per installazioni semplificate



Inverter Onda Modificata

Inverter 150W 230VCA



ARTICOLO	MODELLO	TENSIONE	DIMENSIONE	TELECOMANDO	M.O.	PREZZO €
491929550	MKC-150RS-12-USB	12DC	(Ø x L mm): 70 x 200	no	1	41,26
491929557	MKC-150RS-24-USB	24DC			1	41,26

Inverter 300W 230VCA

491929551	MKC-RS300M-12	12DC	(L x A x P mm): 120 x 55 x 105	no	1	49,35
491929558	MKC-RS300M-24	24DC			1	49,35

Inverter 600W 230VCA

491929552	MKC-RS600M-12	12DC	(L x A x P mm): 150 x 55 x 105	no	1	77,00
491929559	MKC-RS600M-24	24DC			1	77,00

Inverter 1.000W 230VCA

491929553	MKC-RS1000M-12	12DC	(L x A x P mm): 210 x 70 x 150	no	1	155,97
491929560	MKC-RS1000M-24	24DC			1	155,97

Inverter 1.500W 230VCA

491929554	MKC-RS1500M-12	12DC	(L x A x P mm): 250 x 90 x 220	si	1	215,18
491929561	MKC-RS1500M-24	24DC			1	215,18

Inverter 2.000W 230VCA

491929555	MKC-RS2000M-12	12DC	(L x A x P mm): 290 x 90 x 220	si	1	313,91
491929562	MKC-RS2000M-24	24DC			1	313,91

Inverter 3.000W 230VCA

491929556	MKC-RS3000M-12	12DC	(L x A x P mm): 320 x 150 x 220	si	1	452,09
491929563	MKC-RS3000M-24	24DC			1	452,09



MKC-REM02
Telecomando con LED
per inverter MKC serie RS



Art. 491929581
€ 21,72 M.O.:1



INVERTER ONDA MODIFICATA INVERTER ONDA PURA



Inverter Onda Pura

Inverter 600W 230VCA



ARTICOLO	MODELLO	TENSIONE	DIMENSIONE	TELECOMANDO	M.O.	PREZZO €
491929564	MKC-RSP06-12	12DC	(L x A x P mm): 230 x 41 x 150	no	1	215,18
491929569	MKC-RSP06-24	24DC			1	215,18



Inverter 1.000W 230VCA

491929565	MKC-RSP10-12	12DC	(L x A x P mm): 280 x 41 x 250	no	1	274,42
491929570	MKC-RSP10-24	24DC			1	274,42



Inverter 1.500W 230VCA

491929566	MKC-RSP15-12	12DC	(L x A x P mm): 250 x 45 x 220	si	1	373,12
491929571	MKC-RSP15-24	24DC			1	373,12



Inverter 2.000W 230VCA

491929567	MKC-RSP20-12	12DC	(L x A x P mm): 340 x 45 x 220	si	1	531,06
491929572	MKC-RSP20-24	24DC			1	531,06



Inverter 3.000W 230VCA

491929568	MKC-RSP30-12	12DC	(L x A x P mm): 380 x 45 x 220	si	1	787,72
491929573	MKC-RSP30-24	24DC			1	787,72



MKC-REM02
Telecomando
con display LCD
per inverter MKC
serie RSP



Art. 491929580
€ 24,70 M.O.: 1

PRESA DI RETE VOLANTE

ARTICOLO	TIPO	COLORE	FORMA	CONFEZIONE	M.O.	PREZZO €
492518390	10/16A	bianco	arrotondata	blister	1	2,44
492518381				bulk	1	2,11
492518380		nero		1	2,11	
492518389	10/16A	nero	squadrata	blister	1	2,47

SPINA DI RETE VOLANTE

ARTICOLO	TIPO	COLORE	CONFEZIONE	M.O.	PREZZO €
492518394	16A	bianco	blister	1	1,82
492518392	10A			1	1,73
492518379	16A		bulk	1	1,64
492518073	10A	nero	blister	1	1,25
492518391	10A			1	1,82
492518378	16A		bulk	1	1,64
492518074	10A		1	1,23	

SPINA RETE PIATTA 90°

ARTICOLO	TIPO	COLORE	CONFEZIONE	M.O.	PREZZO €
492517938	16A	bianco	doppio blister	1	3,29
492517936	10A			1	2,35
492517933	16A		nero	bulk	1
492517931	10A	1			1,30
492517934	16A	1		1,25	
492517932	10A	1		1,30	

ADATTATORE DI RETE CON SPINA 2P+T E PRESA SCHUKO

ARTICOLO	SPINA	COLORE	CONFEZIONE	M.O.	PREZZO €
492517921	10A	nero	blister	1	1,91
492517922		bianco		1	1,91
492517923	16A	nero		1	2,17
492518025	10A	bianco	bulk	1	1,85
492518026		nero		1	1,85
492517925	16A	bianco	blister	1	2,17
492518028			bulk	1	2,23
492518358		nero	1	2,42	

ADATTATORE DI RETE CON SPINA FRANCO/TEDESCO 16A

ARTICOLO	PRESA	COLORE	CONFEZIONE	M.O.	PREZZO €
492518363	10/16A	bianco	bulk	1	1,82
492518364		nero		1	1,82



MATERIALE ELETTRICO



Adattatore di rete singolo
Bianco, Spina 16A
Presa 2P+T 10/16A Bipasso
Doppio blister

Art. 492518885
€ 2,47 M.O.: 1

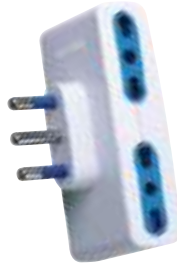

Adattatore di rete quadruplo
Bianco, Spina 16A
4 Prese 2P+T 10/16A Bipasso
Bulk

Art. 492518027
€ 4,88 M.O.: 1



Adattatore di rete triplo
Bianco, spina 16A 2P+T
3 prese bipasso 10/16A

Art. 492518899
€ 5,21 M.O.: 1

ADATTATORE DI RETE TRIPLO

ARTICOLO	SPINA	PRESE	COLORE	CONFEZIONE	M.O.	PREZZO €
492517943	16A	3 x bipasso 10/16A	bianco	doppio blister	1	3,22
492518373				bulk	1	2,98
492517944			nero	doppio blister	1	3,22
492518032	10A	3 x 10A	bianco	bulk	1	2,25
492518031			nero		1	3,11



ADATTATORE DI RETE TRIPLO CON SCHUKO

ARTICOLO	SPINA	PRESE	COLORE	CONFEZIONE	M.O.	PREZZO €
492518066	16A	2 x 10/16A 1 Bip/Schuko	bianco	doppio blister	1	2,98
492518068				bulk	1	2,53
492518036	10A	2 x 10A 1 Schuko	bianco	doppio blister	1	2,73
492518070				bulk	1	2,37
492518067	16A	2 x 10/16A 1 Bip/Schuko	nero	doppio blister	1	2,98
492518071	10A	2 x 10A 1 Schuko		bulk	1	2,37



Adattatore di rete SP 10A

2 prese bipasso 10/16A
+ 1 presa bip/schuko
con interruttore e
protezione da sovraccarico
bianco in blister

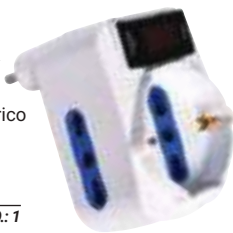

Art. 492519356
€ 6,08 M.O.: 1

Adattatore di rete SP 16A

3 prese bipasso
10/16A
con interruttore
bianco in blister

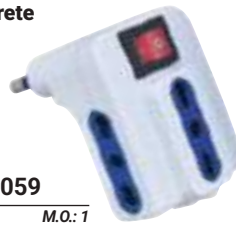

Art. 492518059
€ 4,92 M.O.: 1

Adattatore di rete salvaspazio

2P 10/16A + 1P schuko
bipasso, spina da 10A
con protezione da
sovraccarico, bianco
in blister



Art. 492519355
€ 7,00 M.O.: 1

**Adattatore universale di rete da viaggio
per spine tipo europeo, americano, ed inglese**
Massima corrente in uscita: 6A, 1500W
Confezione in Blister



2



ARTICOLO	MODELLO	COMPOSIZIONE	M.O.	PREZZO €
1 492519362	MK-931	spine: ITA - ENG - DEU - USA	1	9,15
2 492519363	MK-931L	spine: ITA - ENG - DEU - USA 2 USB DC 5V 1A Max	1	13,83

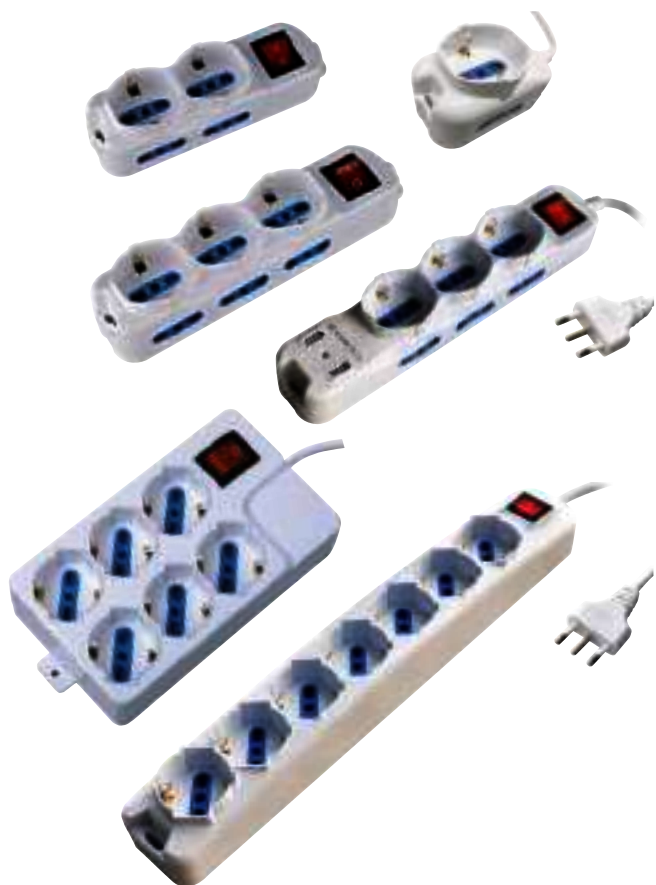

**Multipresa bianca
spina 16A, presa 10/16A + schuko, in polybag, bianco**

ARTICOLO	N. POSTI	COMPOSIZIONE	M.O.	PREZZO €
492518072	3	1 schuko + 2 bipasso	1	6,84
492518053	6	2 schuko + 4 bipasso con interruttore	1	10,48
492518056	9	3 schuko + 6 bipasso con interruttore	1	13,93
492517140	9	3 schuko + 6 bipasso + 2 USB con interruttore	1	25,90
492518078	12	4 schuko/bipasso 10/16A + 8 bipasso 2P + T 16A	1	14,52
492518039	6	6 schuko/bipasso 10/16A	1	14,52
492517130	7	7 schuko/bipasso 10/16A	1	13,89



**Nuovi prodotti basati su tecnologia
Fast Charge PD/QC 3.0**



Il Fast Charge PD (Power Delivery) e QC 3.0 (Quick Charge 3.0) sono due tecnologie di ricarica rapida progettate per ridurre significativamente i tempi di ricarica di dispositivi elettronici come smartphone, tablet e laptop.



Grazie a queste soluzioni innovative, puoi ricaricare i tuoi dispositivi in modo molto più veloce e sicuro rispetto ai caricatori tradizionali. Il sistema regola automaticamente la potenza in base al dispositivo, garantendo prestazioni ottimali e massima protezione. Il connettore USB-C, comodo e reversibile, rende la ricarica semplice, universale e sempre affidabile!



Multipresa da scrivania
bianca con interruttore
3 posizioni schuko bipasso
1 USB-A + 2 USB-C fast charge
spina 90° 16A 2P+T
cavo 1,8mt

*ganci e brugola
compresi
nella confezione*



Art. 492518893
€ 46,77 M.O.: 1



Multipresa
bianca con interruttore
3 posizioni schuko bipasso 10/16A
2 USB-A e 1 USB-C fast charge
spina 90° 16A 2P+T
cavo 1,5mt

Art. 492518892
€ 23,38 M.O.: 1



Multipresa da scrivania
bianca con interruttore
2 prese bipasso 10/16A
2 prese bipasso schuko
2 USB-A e 1 USB-C fast charge
spina 90° 16A 2P+T
cavo 1,5mt

Art. 492518894
€ 26,71 M.O.: 1

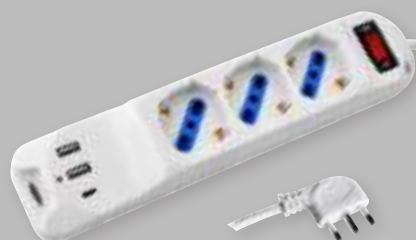



Multipresa bianca con spina 16A salvaspazio 90° presa 10/16A + schuko, con pulsante e protezione da sovraccarico

ARTICOLO	N. POSTI	LUNGHEZZA CAVO	M.O.	PREZZO €
492518887	3	1,5 mt	1	9,38
492518888	4		1	9,98
492518889	5		1	11,03
492518890	6		1	11,95
492518409	4	3 mt	1	12,48
492518440	5		1	14,55
492518411	6		1	16,62



Multipresa spina 16A e prese schuko/bipasso con interruttori singoli e protezione da sovratensione in polybag, bianco

ARTICOLO	N. POSTI	M.O.	PREZZO €
492518054	4	1	16,42
492518055	5	1	17,51
492518038	6	1	20,78

Multipresa bianca n°4 prese schuko/bipasso 10/16A cavo con spina 2p+t 16A in polybag, bianco



Art. 492518318
€ 11,31 M.O.: 1



Multipresa bianca prese bipasso 10/16A spina 2P+T 16A in polybag, bianco

ARTICOLO	N. POSTI	M.O.	PREZZO €
492518040	3	1	6,20
492517976	4	1	6,53
492518079	6	1	6,84



Multipresa nera da esterno IP44 4 prese schuko/10A e interruttore in polybag

Art. 492517134
€ 18,19 M.O.: 1



MATERIALE ELETTRICO
Prolunga elettrica lineare in polybag

ARTICOLO	DESCRIZIONE	CAVO	M.O.	PREZZO €
492517351	10A 3mt bianca	3 x 0,75 mmq	1	7,27
492517352	10A 3mt nera	3 x 0,75 mmq	1	8,61
492517353	10A 5mt bianca	3 x 0,75 mmq	1	12,73
492517354	10A 5mt nera	3 x 0,75 mmq	1	12,73
492517356	10A 10mt nera	3 x 1 mmq	1	24,53
492517358	10A 3mt nera	3 x 1 mmq	1	7,93
492517360	16A 5mt nera	3 x 1 mmq	1	10,06
492517384	16A 3mt bianca	3 x 1 mmq	1	8,97

Prolunga elettrica bianca con spina salvaspazio 90°

ARTICOLO	DESCRIZIONE	CAVO mmq	LUNGHEZZA	M.O.	PREZZO €
492517390	spina 10A presa 10A	3 x 1	3 mt	1	9,56
492517391		3 x 1	5 mt	1	10,91
492517392		3 x 1	10 mt	1	26,00
492517393	spina 16A	3 x 1	5 mt	1	11,45
492517394	presa bipasso 10/16A	3 x 1,5	10 mt	1	27,01
492517395	spina schuko	3 x 1	3 mt	1	10,29
492517396	presa schuko bipasso 10/16A	3 x 1	5 mt	1	12,48
492517397	spina 16A	3 x 1	3 mt	1	9,56
492517398	presa schuko bipasso 10/16A	3 x 1	5 mt	1	12,27

**Avvolgicavo 5 mt
2 prese bipasso
10/16A
spina 16A
con protezione
termica
ripristinabile**

Art. 492518042
€ 20,77 M.O.: 1

**Avvolgicavo 8 mt
2 prese bipasso
10/16A
spina 16A
con protezione
termica
ripristinabile**

Art. 492518043
€ 29,26 M.O.: 1

**Avvolgicavo 25 mt
4 prese bipasso
10/16A
spina 16A
con protezione
termica
ripristinabile**

Art. 492518044
€ 83,28 M.O.: 1

CRONOTERMOSTATI E TIMER

IR-683 (wired) e MK-725 (wireless) cronotermostati digitali settimanali.

SPECIFICHE E FUNZIONI

- Programmazione giornaliera e settimanale con funzionamento automatico secondo program.
- Suddivisione giornaliera in 6 fasce
- Modalità settimanale 5+2, 6+1 o 7 giorni
- Fasce orarie impostabili al singolo minuto
- Temperature impostabili a passi di 0,5 gradi per ciascuna fascia
- Funzionamento manuale

- Modalità spento
- Funzione blocco tastiera
- Notazione Celsius/Fahrenheit
- Protezione antigelo con temperatura impostabile
- Regolazioni di temperatura minima e massima
- Calibrazione termometrica
- Regolazione isteresi di avvio

DATI TECNICI

- Alimentazione: 2 x batterie 1,5 V AA (non incluse)
- Uscita: relé a contatto pulito
- Capacità di contatto:
IR-683 = 2A/30VDC 0,5A/125VAC 0,25A/250VAC
MK-725 = 10 A/220 V (riscaldamento elettrico RF)
- Gamma di impost. temp.: 5°C ~ 35°C (default)
- Gamma di selezione temp.: 1°C ~ 70°C
- Installazione: a parete e scatola 3 moduli
- Dimensioni (LxAxP):
IR-683 = 130,3 x 90,1 x 26,6 mm
MK-725 = 130,02*90,11*27,40 mm (mod. controllo)
 85,96*28,84*85,81 mm (ricevente)

IR-683 (wired)



IRRADIO
Play the future

Art. 493933781

€ 50,42 M.O.: 1

MK-725 (wireless)



melchioni
mkc

Art. 493933769

€ 89,15 M.O.: 1



Termostato meccanico

TH-555C

Termostato ambientale analogico ad alte performance di semplice utilizzo. Indicatori: On/Off.

Art. 493933758

€ 21,04 M.O.: 1

melchioni
mkc

Timer meccanici e digitali

	ARTICOLO	MODELLO	TIPO	PROGR.	M.O.	PREZZO €
1	493933772	MKTI-4A	meccanico da esterno	giornaliera 24 h	1	11,70
2	493933771	MKTIW-1	meccanico con switch	settimanale	1	11,29
3	493933770	MKTI-2	meccanico con switch	giornaliera 24 h	1	8,59
4	493933774	MKTGE-5	digitale da esterno	settimanale	1	20,94
5	493933773	MKTIE-2	digitale	settimanale	1	15,90



SENSORI DI MOVIMENTO PIR

MX44
Sensore PIR da parete



Art. 499048735

€ 8,68 M.O.: 1

MX65
Sensore PIR IP65 da parete



Art. 499048736

€ 10,87 M.O.: 1

MX100
Sensore IP20 presenza umana



Rileva la presenza di persone anche in assenza di movimento

Art. 499048737

€ 21,53 M.O.: 1

LX40 BIANCO
Sensore di movimento pir da parete ad infrarossi 180° max 12mt bianco



Art. 499048725

€ 12,55 M.O.: 1

LX06
Sensore di movimento pir per soffitto ad infrarossi 360° 2-12mt bianco



Art. 499048720

€ 11,46 M.O.: 1

OTTIMIZZA L'EFFICIENZA E L'AUTOMAZIONE DEI TUOI IMPIANTI CON LA NUOVA GAMMA DI TIMER SU GUIDA DIN!

Scopri la nostra selezione di soluzioni professionali su guida DIN: dai classici ed efficienti timer meccanici giornalieri ai modelli digitali avanzati con funzione alba/tramonto, fino ai temporizzatori elettronici luce scale multifunzione (da 6 a 10 funzioni) per la gestione intelligente di corridoi, garage e aree comuni.

MKTI-1014
Timer meccanico giornaliero

- Perfetto per quadri civili e industriali (barra DIN).
- Gestisce illuminazione, riscaldamento, irrigazione e automazione.
- Adatto a carichi pesanti senza necessità di moduli aggiuntivi.
- Forza accensione/spengimento senza alterare il programma impostato.

Guida DIN 1 Modulo

Tempo di autonomia 100h se disconnesso

Art. 493933776

€ 14,28 M.O.: 1



MKTI-1020
Timer meccanico giornaliero

- Elevata portata per carichi monofase e funzione bypass per il controllo manuale immediato.
- Ideale per illuminazione, termoregolazione, irrigazione, sicurezza e automazione.
- Installazione standard rapida e programmazione giornaliera intuitiva.

Guida DIN 3 Moduli

Tempo di autonomia 200h se disconnesso

Art. 493933775

€ 24,65 M.O.: 1



MKTI-1024
Timer digitale giornaliero/settimanale, con funzione alba/tramonto automatico

- Gestione giornaliera e settimanale di carichi elettrici (Illuminazione esterna / interna, insegne e vetrine, impianti di ventilazione, pompe e irrigazione).
- Unisce la precisione digitale a funzioni evolute per il controllo intelligente dell'energia.
- Compatto e affidabile, ideale per ottimizzare il centro di comando del tempo in ogni quadro elettrico.

Guida DIN 2 Moduli

Tempo di autonomia 6 mesi se disconnesso

Art. 493933780

€ 25,73 M.O.: 1



TK-1CP
Temporizzatore elettronico luce scale contatto pulito

Prodotto compatto, affidabile e potente, è progettato per comandare illuminazione, ventilazione, pompe, insegne e dispositivi elettrici con gestione semplice e sicura. Guida DIN - Relè SPDT con selettore OFF / AUTO / ON.

Guida DIN 1 Modulo

Contatto pulito

Art. 493933777

€ 17,52 M.O.: 1



TK-6F
Temporizzatore elettronico luce scale 6 funzioni

Temporizzatore elettronico compatto e professionale progettato per la gestione efficiente dell'illuminazione di scale, corridoi, garage e ambienti comuni. Combina semplicità di utilizzo, versatilità operativa e affidabilità nel tempo, offrendo 6 modalità di funzionamento per adattarsi a ogni esigenza impiantistica.

Guida DIN 1 Modulo

6 funzioni preimpostate personalizzabili

Art. 493933778

€ 16,44 M.O.: 1



TK-10F
Temporizzatore elettronico luce scale 10 funzioni

Temporizzatore elettronico professionale per la gestione intelligente dell'illuminazione di scale, corridoi, garage e ambienti comuni. Compatto (solo 1 modulo DIN), potente e versatile, integra 10 funzioni operative per adattarsi a ogni tipo di impianto e stile d'uso.

Guida DIN 1 Modulo

10 funzioni preimpostate personalizzabili

Art. 493933779

€ 24,04 M.O.: 1



PLATINUM
SERIES

 UHD
8K
Risoluzione

UHD 8K 4320P@60FPS / UHD 4K 2160P@120FPS

Conduttori in rame | Connettore in metallo con contatti dorati | spina HDMI - spina HDMI

ARTICOLO	MODELLO	LUNGHEZZA	CONFEZ.	AWG / DHCP	MATERIALE COND.	MATERIALE GUAINA	M.O.	PREZZO €
149029141	IR-8KPL.1	1 mt	box appendibile	AWG 30 / 0,254 mm DHCP 2.3	CU	PVC+ tram in nylon nero	1	9,90
149029143	IR-8KPL.3	3 mt					1	18,05
149029144	IR-8KPL.5	5 mt					1	32,55
149029145	IR-8KPL.7	7 mt					1	41,11

 GOLD
SERIES

 UHD
4K
Risoluzione

UHD 4K 2160P@60FPS / 2K 1440P@120FPS

Conduttori in rame | Connettore in plastica con contatti dorati | spina HDMI - spina HDMI

ARTICOLO	MODELLO	LUNGHEZZA	CONFEZ.	AWG / DHCP	MATERIALE COND.	MATERIALE GUAINA	M.O.	PREZZO €
149029155	IR-4KG.0.5	0,5 mt	box appendibile	AWG 30 / 0,254 mm DHCP 2.2	CU	PVC nero	1	3,98
149029156	IR-4KG.1	1 mt					1	4,83
149029158	IR-4KG.3	3 mt					1	9,15
149029159	IR-4KG.5	5 mt					1	14,96
149029161	IR-4KG.10	10 mt					1	33,09
149029162	IR-4KG.15	15 mt					1	54,34
149029163	IR-4KG.20	20 mt					1	60,15

 Conduttori in rame integrati con **fibra ottica** | Connettore in metallo con contatti dorati | spina HDMI - spina HDMI

Fibra ottica



ARTICOLO	MODELLO	LUNGHEZZA	CONFEZ.	AWG / DHCP	MATERIALE COND.	MATERIALE GUAINA	M.O.	PREZZO €
149029176	IR-AOC4KG.30	30 mt	scatola	AWG 28 / 0,321 mm DHCP 2.2	CU + fibra ottica	PVC nero	1	81,34
149029177	IR-AOC4KG.40	40 mt					1	89,69
149029178	IR-AOC4KG.50	50 mt					1	108,04
149029180	IR-AOC4KG.75	75 mt					1	148,80
149029181	IR-AOC4KG.100	100 mt					1	187,54

 Silver
SERIES

 UHD
4K
Risoluzione

UHD 4K 2160p@30FPS / Full HD 1080P@60FPS

Conduttori in acciaio e rame | Connettore in plastica con contatti dorati | spina HDMI - spina HDMI

ARTICOLO	MODELLO	LUNGHEZZA	CONFEZ.	AWG / DHCP	MATERIALE COND.	MATERIALE GUAINA	M.O.	PREZZO €
149029195	IR-4KS.0.5	0,5 mt	polybag appendibile	AWG 26 / 0,40 mm DHCP 1.4	CCS	PVC nero	1	3,07
149029196	IR-4KS.1	1 mt					1	3,98
149029197	IR-4KS.1.5	1,5 mt					1	4,30
149029198	IR-4KS.2	2 mt					1	2,96
149029199	IR-4KS.3	3 mt					1	5,11
149029230	IR-4KS.5	5 mt					1	7,34
149029231	IR-4KS.10	10 mt					1	15,30
149029232	IR-4KS.15	15 mt	sacchetto				1	33,66
149023233	IR-4KS.20	20 mt					1	60,15
149023234	IR-4KS.25	25 mt					1	101,94

 FullHD
SERIES

 Full HD
1080p
Risoluzione

Full HD 1080P - 1440P@60Hz

Conduttori in acciaio e rame | Connettore in plastica con contatti dorati | spina HDMI - spina HDMI

ARTICOLO	MODELLO	LUNGHEZZA	CONFEZ.	AWG / DHCP	MATERIALE COND.	MATERIALE GUAINA	M.O.	PREZZO €
149029190	IR-1080P.0.5	0,5 mt	polybag appendibile	AWG 30 / 0,254 mm DHCP 1.2	CCS	PVC nero	1	2,25
149029191	IR-1080P.1	1 mt					1	2,35
149029192	IR-1080P.1.5	1,5 mt					1	2,50
149029193	IR-1080P.2	2 mt					1	3,16
149029194	IR-1080P.3	3 mt					1	3,41

CAVI HDMI



FPS: 4K / 60Hz, 4K / 30Hz, 1080P 60Hz

Cavo HDMI Alta Velocità con Ethernet, Connettori Dorati Versione 2.0, ARC Compatibile UHD 2160p, 4K, 3D, 19pin

ARTICOLO	MODELLO	LUNGHEZZA	CONFEZ.	AWG	MATERIALE COND.	MATERIALE GUAINA	M.O.	PREZZO €
149029131	MK-BL-0.51V2	0.5 mt	blister	30	CU	Nylon a treccia	1	5,99

DIVISORI HDMI

ARTICOLO	MODELLO	HDMI	VERSIONE	M.O.	PREZZO €
149029709	MK-SP2	HDMI 1 x 2	1.4B	1	30,11
149029710	MK-SP4	HDMI 1 x 4	1.4B	1	41,68
149029711	MK-SP8	HDMI 1 x 8	1.4B	1	73,29



Divisore HDMI Full HD 4K 60Hz HDCP 2.2

Funzione EDID

ARTICOLO	MODELLO	HDMI	VERSIONE	M.O.	PREZZO €
149029712	MK-911-2plus	HDMI 1 x 2	2.0	1	70,81
149029713	MK-911-4plus	HDMI 1 x 4	2.0	1	91,17
149029714	MK-911-8plus	HDMI 1 x 8	2.0	1	169,41

Divisore HDMI Full HD 4Kx2K 30Hz



MK-SS2-2-V2.0 Matrice (Divisore/Selettore) HDMI 4K 60Hz V2.0A 2in x 2out HDCP 2.2

Art. 149029715
€ 70,81 M.O.: 1



SELETTORI HDMI

Selettore HDMI 4Kx2K 30Hz

ARTICOLO	MODELLO	HDMI	VERSIONE	M.O.	PREZZO €
149029716	MK-DSW3-N	HDMI 3 x 1	1.4B	1	18,77
149029717	MK-DSW4-M	HDMI 4 x 1	1.4B	1	26,45

MK-DSW4 Selettore HDMI 1.4B 4Kx2K 30Hz 4in x 1out con estrattore audio

Art. 149029718
€ 55,65 M.O.: 1



MK-DSW5 Selettore HDMI 1.4A Full HD 1080p 5in x 1out

Art. 149029719
€ 63,33 M.O.: 1



Selettore HDMI 2.0A e 2.0B UHD 4K 60Hz HDCP 2.2

ARTICOLO	MODELLO	HDMI	VERSIONE	M.O.	PREZZO €
149029720	MK-DSW5 2.0	HDMI 5 x 1	2.0A	1	70,81
149029721	MK-DSW3 2.0	HDMI 3 x 1	2.0B	1	63,33
149029722	MK-DSW4 2.0	HDMI 4 x 1	2.0B	1	73,29
149029723	MK-DSW7 2.0	HDMI 7 x 1	2.0B	1	96,14



CONVERTITORI HDMI

YZ-1801
Convertitore
da VGA a PAL/NTSC



Prodotto in fine serie!

Art. 149029083
€ 17,87 M.O.: 1

Convertitore
da HDMI a HDMI
con estrattore audio
Funzione EDID



ARTICOLO	MODELLO	CONVERSIONE	M.O.	PREZZO €
149029726	MK-HDC03	4K 30Hz da HDMI a HDMI	1	63,33
149029727	MK-HDC03 2.0	4K 60Hz da HDMI a HDMI	1	91,17



MK-CAV01
Convertitore
1080p 60Hz da CVBS
+ audio ad HDMI

Art. 149029728
€ 55,65 M.O.: 1



MKHDCVGA01-P
Convertitore
1080P 60Hz da VGA
+ audio a HDMI

Art. 149029082
€ 25,08 M.O.: 1



MKHDCAV02-M
Convertitore
da HDMI ad CVBS
+ audio

Art. 149029080
€ 29,18 M.O.: 1

ESTENSORI HDMI

IR-HD40EXT
Estensore HDMI
Wireless Full HD, 40mt



Art. 149029300
€ 78,88 M.O.: 1

MK-1560 Estensore
HDMI fino a 60mt
su singolo Cat5e/6
1080p 60Hz



Art. 149029700
€ 65,82 M.O.: 1



MK-60-V2.0 TX + RX
Kit Estensore HDMI 2.0 4K 60Hz
fino 60mt con collegamento in cascata

ARTICOLO	DESCRIZIONE	M.O.	PREZZO €
149029702	MK-60-V2.0 TX + RX Kit Estensore	1	175,75
149029703	MK-60-V2.0 RX RX aggiuntivo	1	93,64

MKES29
Estensore HDMI
over IP fino a 200mt
su CAT5e/6
in tecnologia KVM



Art. 149029740
€ 138,55 M.O.: 1

CONTROLLER HDMI PER VIDEO WALL

MK-VW2X2
Controller HDMI per video
wall 4Kx2K 30Hz 2x2



Art. 149029731
€ 478,18 M.O.: 1



CAVI AUDIO VIDEO



**Cavetto Audio Stereo
2RCA-2RCA Spina-Spina
Colore Nero**



**Cavetto Audio Stereo
Mini Jack 3.5/2RCA Spina-Spina
Colore Nero, polybag**

ARTICOLO	MODELLO	MT	CONF	M.O.	PREZZO €
149000249	MK1011/M/P 3MT P	3	Polybag	1	2,24
149000250	MK1011/M/P 5MT P	5	Polybag	1	2,84
149000170	MK1011/M/P 1,5MT BL	1,5	Blister	1	2,09

ARTICOLO	MODELLO	MT	M.O.	PREZZO €
149000252	MK4041/M/P/1.5M P	1,5	1	1,42
149000253	MK4041/M/P/3M P	3	1	1,67
149000254	MK4041/M/P/5 P	5	1	2,35



Cavetto Audio Stereo
Mini Jack 3.5 / Mini Jack 3.5, Spina-Spina
colore nero, in polybag

ARTICOLO	MODELLO	MT	M.O.	PREZZO €
149000257	MK4031/M/P1.5M P	1,5	1	1,24
149000258	MK4031/3M P	3	1	1,65



MK4032/M/B 1,5MT P
Cavetto Audio, Stereo
Mini Jack 3.5 / Mini Jack 3.5
spina-presa, colore nero
in polybag, lunghezza cavo 1,5 mt

Art. 149000260
€ 1,84 M.O.: 1

ARTICOLO	MODELLO	MT	CONFEZIONE	M.O.	PREZZO €
149000175	MK2004/M/B 1,5MT BL	1,5	Blister	1	4,78
149000263	MK2004/M/B 3MT P	3	Polybag	1	5,54

**Cavetto Audio, Digitale Ottico
TOSLINK / TOSLINK
Spina-Spina, Colore Nero**



ARTICOLO	MODELLO	CONVERSIONE	M.O.	PREZZO €
149029724	MK-HDC7	Digitale > Analogico R/L SPDF e COAX	1	21,36
149029725	MK-HDC8	Analogico R/L > Digitale SPDF e COAX	1	28,50

**Convertitore
Audio**



Scopri di più su
www.melchioni-ready.com



Caratteristiche comuni alla serie supporti TV

Piastra in acciaio

Livella integrata per posizionamento semplice

Due pezzi "slide-in" per un il montaggio facilitato

Sistema di gestione di routing cavi

Kit di fissaggio incluso

Colore nero



STV-IR-1027-FIX
Supporto TV 10"-27"
a muro fisso

Art. 149302110
€ 4,57 M.O.: 1



STV-IR-1027-TILT
Supporto TV 10"-27"
a muro inclinabile

Art. 149302111
€ 6,38 M.O.: 1



STV-IR-1027-1
Supporto TV 10"-27"
ad uno snodo

Art. 149302112
€ 11,77 M.O.: 1



STV-IR-1027-2
Supporto TV 10"-27"
a due snodi

Art. 149302113
€ 18,95 M.O.: 1

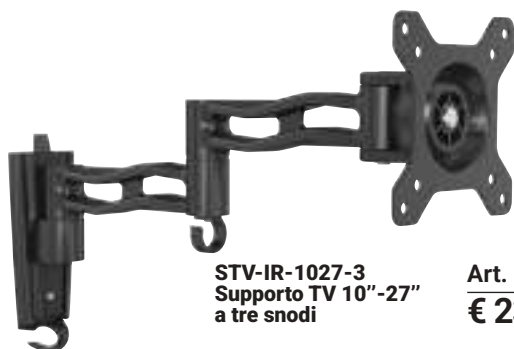

STV-IR-1027-3
Supporto TV 10"-27"
a tre snodi

Art. 149302114
€ 23,91 M.O.: 1



STV-IR-1742-FIXA
Supporto TV 17"-42"
a muro fisso

Art. 149302115
€ 9,96 M.O.: 1



STV-IR-1742-1
Supporto TV 17"-42"
ad uno snodo

Art. 149302116
€ 16,94 M.O.: 1



STV-IR-1742-2
Supporto TV 17"-42"
a due snodi

Art. 149302117
€ 20,94 M.O.: 1

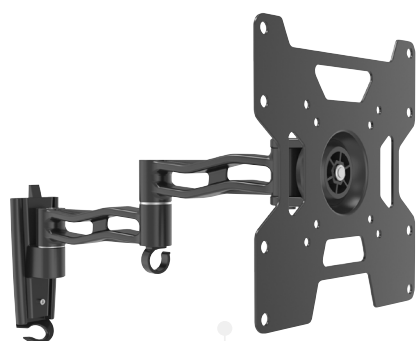

STV-IR-1742-3
Supporto TV 17"-42"
a tre snodi

Art. 149302118
€ 27,72 M.O.: 1



STV-IR-2255-FIXA
Supporto TV 22"-55"
a muro fisso

Art. 149302119
€ 15,94 M.O.: 1



STV-IR-2370-FIXA
Supporto TV 32"-70"
a muro fisso

Art. 149302120
€ 18,95 M.O.: 1



STV-IR-2255-3
Supporto TV 22"-55"
a tre snodi

Art. 149302121
€ 43,86 M.O.: 1



STV-IR-2255-FIXB
Supporto TV 22"-55"
a muro fisso

Art. 149302122
€ 15,94 M.O.: 1



STV-IR-4280-FIXB
Supporto TV 42"-80"
a muro fisso

Art. 149302123
€ 14,95 M.O.: 1

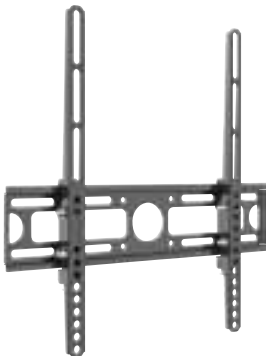

STV-IR-2255-TILT
Supporto TV 22"-55"
a muro inclinabile

Art. 149302124
€ 19,94 M.O.: 1

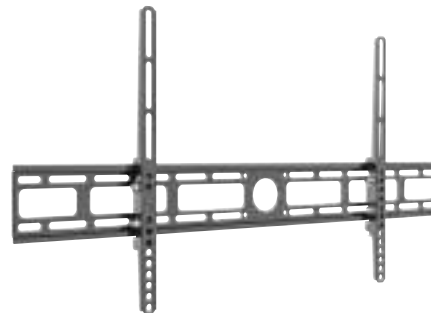

STV-IR-4280-FIXB
Supporto TV 42"-80"
a muro inclinabile

Art. 149302125
€ 23,91 M.O.: 1

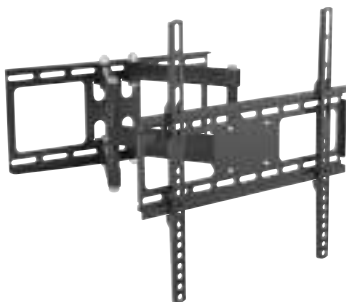

STV-IR-3270-3
Supporto TV 32"-70"
a pantografo tre snodi

Art. 149302126
€ 61,79 M.O.: 1



STV-IR-5090-3
Supporto TV 50"-90"
a pantografo tre snodi

Art. 149302127
€ 69,76 M.O.: 1



visita il nostro sito
www.melchioni-ready.com



SUPPORTI DIFFUSORI, VIDEOPROIETTORI - SERIE GOLD



STV-IR-2255-S
Supporto TV 22"-55"
da soffitto, con discesa
regolabile 444-794 mm

Art. 149302128
€ 71,75 M.O.: 1



STV-IR-1742-S
Supporto TV 17"-42"
da soffitto, con discesa
regolabile 272-332 mm

Art. 149302129
€ 35,88 M.O.: 1

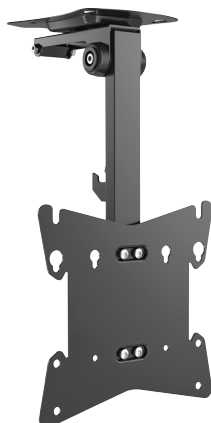

SD-IR-WALLSOUND
Coppia di supporti
per diffusori da parete
in plastica nera

Art. 149302140
€ 5,79 M.O.: 1



SD-IR-FLOORSOUND
Coppia di supporti per
diffusori da pavimento
in metallo verniciato nero

Art. 149302141
€ 49,82 M.O.: 1



SP-IR-CEILING-135
Supporto da soffitto per videoproiettori
distanza da soffitto 135mm

Art. 149302142
€ 15,94 M.O.: 1

SP-IR-CEILING-240/310
Supporto da soffitto per videoproiettori
distanza da soffitto 240-310mm

Art. 149302143
€ 25,91 M.O.: 1

SUPPORTI TV - SERIE SILVER

Caratteristiche comuni alla serie supporti TV
Acciaio laminato a freddo di colore nero
Livella integrata per posizionamento semplice

Sistema di gestione di routing cavi
Kit di fissaggio incluso



STV-IR-2242-FIX
Supporto TV 22"-42"
a muro fisso

Art. 149302130
€ 6,72 M.O.: 1



STV-IR-2242-TILT
Supporto TV 22"-42"
a muro inclinabile

Art. 149302131
€ 11,85 M.O.: 1



STV-IR-42100-FIX
Supporto TV 42"-100"
a muro fisso

Art. 149302132
€ 27,65 M.O.: 1



STV-IR-3255-3
Supporto TV 32"-55"
a tre snodi

Art. 149302133
€ 21,72 M.O.: 1



STV-IR-3970-3
Supporto TV 39"-70"
a tre snodi

Art. 149302134
€ 41,45 M.O.: 1

ACCESSORI TV SAT



AMPLIFICATORE DA INTERNO

ARTICOLO	MODELLO	IN / OUT	GUADAGNO	M.O.	PREZZO €
559578332	ZDA-0611	1 / 1	VHF 24db UHF 30db	1	24,54
559578333	ZDA-0612	1 / 2	VHF 20db UHF 27db	1	24,54
559578334	ZDA-7114	1 / 4	VHF 24db UHF 30db	1	28,83

DIVISORE DA INTERNO DC SAT/DTT

ARTICOLO	MODELLO	IN / OUT	M.O.	PREZZO €
559578343	ZDSSL-0102AP/A	1 / 2	7	2,38
559578344	ZDSSL-0103AP/A	1 / 3	5	3,76
559578345	ZDSSL-0104AP/A	1 / 4	4	4,69



ALIMENTATORE DTT 12V

ARTICOLO	MODELLO	IN / OUT	INTENSITÀ	M.O.	PREZZO €
559578349	ZL-301	1 / 1	300 mA	1	14,13
559578350	ZL-302	1 / 2	300 mA	2	15,31
559578335	ZDP-0611	1 / 1	100 mA	1	14,74

ZFP5G
Filtro UHF 5G Free da palo
 Banda passante: 175-694MHz
 Attenuazione: -66dB
 Perdita di passaggio: -0,6dB
 Passaggio +CC: IN/OUT



Art. 559578565
€ 13,47 M.O.: 1

AMPLIFICATORE DVB-T2 5G FREE DA PALO

Regolazione del guadagno: 10 - 20dB
 Livello di uscita: 112dB
 Alimentazione: 12V



ARTICOLO	MODELLO	IN / OUT	BANDA	INT.	GUADAGNO	M.O.	PREZZO €
559578553	ZX3/R3UU	3 / 1	BANDA III / UHF / UHF	100 mA	20dB	1	24,45
559578554	ZX3/RUU	2 / 1	UHF / UHF	100 mA	20dB	1	22,60
559578555	ZX3/RUU 2OUT	2 / 2	UHF / UHF	100 mA	20dB	1	24,87
559578556	ZX3/R45U	3 / 1	B.IV / B.V UHF	100 mA	20dB	1	32,13
559578557	ZX4/R3UU	3 / 1	BANDA III / UHF / UHF	150 mA	20dB 30dB	1	26,95
559578558	ZX4/RUU	2 / 1	UHF / UHF	150 mA	30dB	1	26,53
559578559	ZX4/RUU 2OUT	2 / 2	UHF / UHF	150 mA	30dB	1	25,92
559578560	ZX4/R45U	3 / 1	B.IV / B.V UHF	150 mA	30dB	1	36,29



ACCESSORI TV SAT

MICRO AMPLIFICATORE DVB-T2 5G FREE DA PALO

Ingressi / Uscite: 2 / 1
 Livello di uscita: 110dB
 Alimentazione: 12V 80mA



ARTICOLO	MODELLO	BANDA	GUADAGNO	M.O.	PREZZO €
559578561	ZEB2RUU	UHF / UHF	20dB	1	24,87
559578562	ZEB2R3U	BANDA III / UHF	20dB	1	22,38
559578563	ZEB3RUU	UHF / UHF	30dB	1	24,87
559578564	ZEB3R3U	BANDA III / UHF	30dB	1	24,87



**ZDSN-1102
 MIX/DEMIX
 Miselatore / demiselatore
 SAT- DTT da palo**

Art. 559578378
€ 8,97 M.O.: 1

AMPLIFICATORE DA PALO

ARTICOLO	MODELLO	GUADAGNO VHF / UHF	TIPO	M.O.	PREZZO €
559578325	ZDA-3111F	15 / 30 dB	Log. 1IN / 10OUT: III / UHF	1	20,30
559578326	ZDA-3121	18 / 30 dB	2 IN: VHF+UHF / 1 OUT miscelato	1	20,30
559578328	ZDA-3131B	20 / 30 dB	3 IN: III+UHF+UHF / 1 OUT miscelato	1	22,43

MODULATORE DIGITALE HD

I nuovi modulatori HD 1080p e DVB-T 4K con ingresso video composito forniscono un segnale COFDM RF nella gamma di 50-860MHz. Consistono in una conversione di frequenza, codifica, modulazione A/D che fornisce un'ampiezza di banda selezionabile tra 6/7/8MHz. Sono progettati per supportare gli ingressi CVBS e HDMI e possono anche supportare una codifica standard H.264. Sono una scelta eccellente per trasportare i segnali audio/video dai ricevitori satellitari per TV, telecamere di sorveglianza o lettori video/multimediali ad un televisore LCD o un convertitore di segnale (set-top-box). Possono essere utilizzati in serie con altri modulatori cosicché il numero di canali nel cavo coassiale del sistema SMATV possa essere aumentato come si desidera.



MODULATORE

- Standard DVB-T
- Costellazione QPSK / 16QAM / 64QAM
- Larghezza di banda 6 / 7 / 8 MHz
- Portata 2K / 8K
- Intervallo di guardia 1/4, 1/8, 1/16, 1/32
- Indice codice 1/2, 2/3, 3/4, 5/6, 7/8
- MER 35 dB
- Gamma di frequenza 50 ~ 860 MHz
- Livello d'uscita 70 ~ 100 dBuV
- Impedenza di uscita 75Ω

GENERALI

- Alimentazione DC 12V / 1.5A
- Temperatura di lavoro 0 ~ +50° C
- Dim. (LxWxH) 212 x 121 x 33mm
- Peso 0.9Kg

VIDEO

- Formato d'ingresso CVBS/HDMI
- Formato di codifica H.264
- Risoluzione Video
 - 576i PAL / 480i NTSC / 1080p (559578490)
 - 576i PAL / 480i NTSC / 1080p / 4K (559578491)
- Risoluzione uscita
 - Loop Max to 1080p (559578490)
 - Loop Max to 4K (559578491)
- Risoluzione uscita RF Max to 1080p30
- Connettore RCA/HDMI 2.0

AUDIO

- Formato d'ingresso Stereo L/R channel
- Formato codifica MPEG-1 Audio Layer II
- Connettore RCA

ARTICOLO	MODELLO	RISOLUZIONE	M.O.	PREZZO €
559578490	ZDB-T6000HD	Full HD 1080p	1	239,14
559578491	ZDB-T70004K	4K	1	298,91

ANTENNE DTT DA INTERNO



melchioni
mkc

SIDEREA

Antenna DTT da interno
amplificata VHF/UHF

Art. 149898001

€ 30,64 M.O.: 1



IRRADIO

Play the future



IR-Digital 1 USB

Antenna amplificata Irradio,
alimentazione 5V tramite USB
Frequenza UHF 470-700Mhz
Guadagno: UHF:18dB

5GLTE
ready

Art. 149898040

€ 31,58 M.O.: 1



IR-Digital 2 USB

Antenna amplificata Irradio,
alimentazione 5V tramite USB
Frequenza UHF 470-700Mhz
Guadagno: UHF:19dB

Art. 149898041

€ 33,64 M.O.: 1

5GLTE
ready



IR-Digital Easy

Mini antenna passiva Irradio,
Frequenza UHF 470-700Mhz
Guadagno: UHF:3dB

Art. 149898043

€ 14,74 M.O.: 1

5GLTE
ready

ANTENNE DTT OMNIDIREZIONALI



IRRADIO

Play the future

IR-Digital OMNI 1

Antenna DVB-T2 omnidirezionale
da esterno amplificata Irradio
Frequenza UHF 470-700Mhz
Guadagno: UHF:18dB
5G Free

5GLTE
ready

Art. 149898044

€ 63,16 M.O.: 1



SATURN

Antenna esterna
omni direzionale
amplificata
VHF/UHF

12V

Art. 149898032

€ 55,74 M.O.: 1

ANTENNE DTT

Antenna ZD-15-4
VHF CH 6-12 4 elementi

Art. 559573437

€ 20,70 M.O.: 15



ANTENNE DTT 5G FREE

Nuova gamma IRRADIO e Zodiac dtt di **antenne digitali terrestri 5G LTE ready**, ottime per la ricezione del nuovo segnale digitale terrestre **DVB-T2 HEVC Main 10**, per le trasmissioni televisive con segnali HD e UHD. Le loro frequenze di lavoro 470-694Mhz le rendono immuni da qualsiasi possibile interferenza del segnale 5G in uso alla telefonia mobile.



IRRADIO
Play the future



Antenna IR-D27-5G
Antenna tripla DDT 5G ready
Banda UHF, 27 elementi
Canali 21- 48
Frequenza 470 - 694 Mhz
Guadagno 8 - 12,5 dB

Art. 559573520
€ 29,06 M.O.: 6



Antenna IR-D12-5G
Antenna DDT 5G ready
Banda UHF, 12 elementi
Canali 21- 48
Frequenza 470 - 694 Mhz
Guadagno 9,5 - 13,5 dB

Art. 559573521
€ 30,95 M.O.: 10

Screwsless

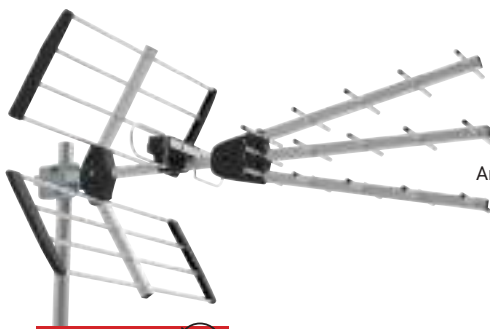

Antenna IR-D17-5G
Antenna tripla DDT 5G ready
Banda UHF, 17 elementi
Canali 21- 48
Frequenza 470 - 694 Mhz
Guadagno 8 - 12 dB

Art. 559573522
€ 34,01 M.O.: 10

Screwsless



Antenna IR-D23-5G
Antenna tripla DDT 5G ready
Banda UHF, 23 elementi
Canali 21- 48
Frequenza 470 - 694 Mhz
Guadagno 12 - 17 dB

Art. 559573523
€ 45,40 M.O.: 8

Screwsless

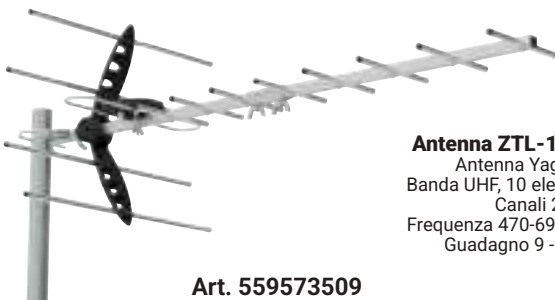

Antenna ZTL-10-5G
Antenna Yagi DDT,
Banda UHF, 10 elementi,
Canali 21- 48,
Frequenza 470-694 Mhz
Guadagno 9 - 13 dB

Art. 559573509
€ 19,75 M.O.: 10

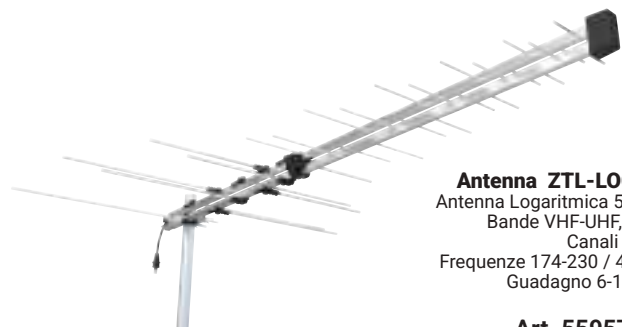

Antenna ZTL-LOG160V-5G
Antenna Logaritmica 5G ready V/O
Bande VHF-UHF, 16 elementi
Canali 5-12 / 21-48
Frequenze 174-230 / 470-694 Mhz
Guadagno 6-13 / 11-13 dB

Art. 559573511
€ 28,21 M.O.: 5

Installazione V/O



NEW Design

NEW Performance

Antenna ZTL-38-5G
Antenna tripla DDT 5G ready
Banda UHF, 38 elementi
Canali 21- 48,
Frequenza 470-694 Mhz
Guadagno 15-17 dB

Art. 559573510
€ 29,15 M.O.: 10



Antenna ZTL-368B5G
Antenna DDT,
Banda UHF, 14 elementi,
Canali 21- 48,
Frequenza 470-694 Mhz
Guadagno 8 - 10 dB

Art. 559573501
€ 30,34 M.O.: 1



Antenna ZTL-368C5G
Antenna DDT,
Banda UHF, 8 elementi,
Canali 21- 48,
Frequenza 470-694 Mhz
Guadagno 9 - 13 dB

Art. 559573502
€ 31,39 M.O.: 1

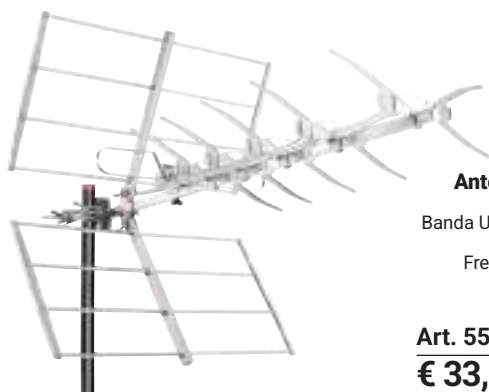

Antenna ZTL-118F5G
Antenna tripla DDT,
Banda UHF, 23 elementi ad X,
Canali 21- 48,
Frequenza 470-694 Mhz
Guadagno 12 - 14 dB

Art. 559573503
€ 33,48 M.O.: 1



Antenna ZTL-2335G
Antenna tripla DDT,
Banda UHF, 43 elementi,
Canali 21- 48,
Frequenza 470-694 Mhz
Guadagno 16 - 18 dB

Art. 559573504
€ 39,55 M.O.: 1



Antenna ZTL-236B5G
Antenna tripla DDT,
Banda UHF, 29 elementi,
Canali 21- 48,
Frequenza 470-694 Mhz
Guadagno 10 - 15 dB

Art. 559573507
€ 30,55 M.O.: 1

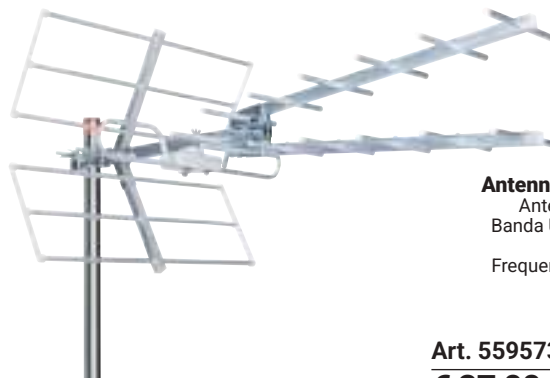

Antenna ZTL-39495G
Antenna doppia DDT,
Banda UHF, 15 elementi,
Canali 21- 48,
Frequenza 470-694 Mhz
Guadagno 13 dB

Art. 559573508
€ 27,00 M.O.: 1

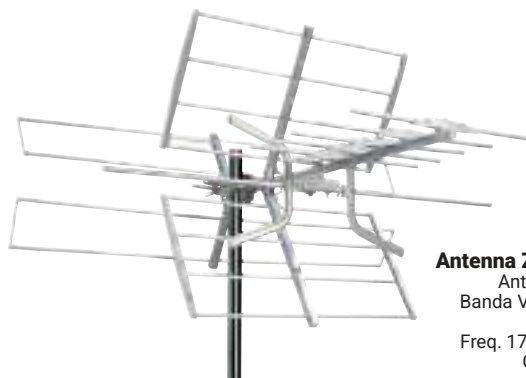

Antenna ZTL-368C05UV5G
Antenna combo VU DDT,
Banda VHF UHF, 20 elementi,
Canali 6- 12 / 21- 48,
Freq. 170-230 / 470-694 Mhz
Guadagno VHF 10 dB
UHF 12 - 15 dB

Art. 559573505
€ 42,90 M.O.: 1

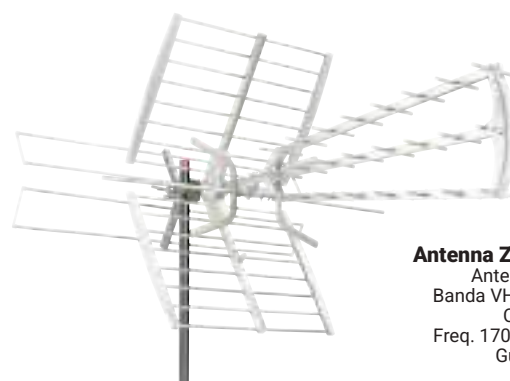

Antenna ZTL-233-05UV5G
Antenna combo VU DDT,
Banda VHF UHF, 47 elementi,
Canali 6- 12 / 21- 48,
Freq. 170-230 / 470-694 Mhz
Guadagno VHF 12 dB
UHF 16 - 18 dB

Art. 559573506
€ 50,22 M.O.: 1



ANTENNE SATELLITARI

Antenne Satellitari realizzate con procedimento di stampaggio ad alta precisione per una costante qualità di produzione.

Il riflettore in lamiera di acciaio zincata e la verniciatura realizzata a polveri per esterni ne fanno un prodotto di alta qualità e durabilità nel tempo.

Fornite con supporto fisso con incisa la scala di regolazione dell'alzo.



ARTICOLO	MODELLO	Ø DISCO	GUADAGNO	M.O.	PREZZO €
559573146	ZD-4501	45 cm	33.0 dB @12 GHz	1	29,69
559573147	ZD-6025	60 cm	36.0 dB @12 GHz	25	35,64
559573148	ZD-8012	80 cm	38.8 dB @12 GHz	12	49,47



Certificata SKY

ZD-8050SK Antenna Satellitare con disco in acciaio ø 80cm

Ideale per impianti singoli e sistemi centralizzati o impianti multi-satellite.

- Riflettore: acciaio zincato
- Supporto del disco: Polipropilene - 30% fibra di vetro
- Guadagno: 38 dB @12 GHz
- Fissaggio al palo Ø: da 30 a 60mm
- Fissaggio LNB Ø: da 23 a 40mm
- Alzo massimo: da 0° a 65°
- Palo passante: 43°

Art. 559573149

€ 43,55 M.O.: 50

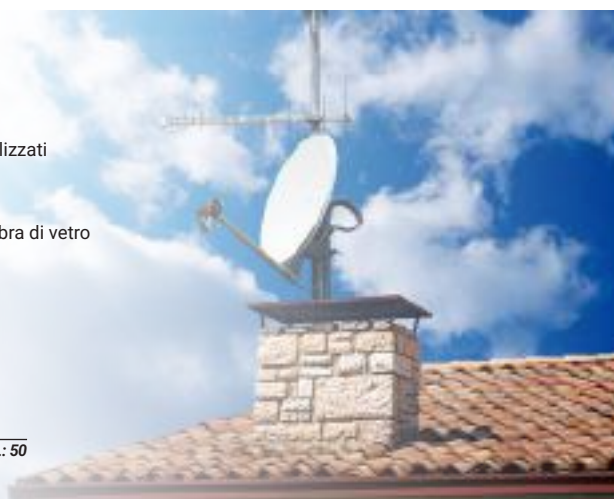

LNB

CONVERTITORE LNB

ARTICOLO	MODELLO	TIPO	M.O.	PREZZO €
559571095	TS100F	convertitore singolo universale	5	5,34
559571086	TS201F TWIN	2 uscite indipendenti	2	15,86
559571084	TS401F QUAD	4 uscite indipendenti	6	25,00
559571088	TS410F QUATRO	4 uscite polarizzate HV / HV	2	20,17

TELE System



CAVETTI TV SAT



MK4019/M/P 1,5MT BL
Cavetto Satellite F/F 1,5 mt
Spina-Spina bianco in blister

Art. 149000176

€ 2,09 M.O.: 1



MK4009/M/B WHITE 2,5MT P
Cavetto TV IEC/IEC 90° 2,5 mt
Spina-Spina bianco in polybag

Art. 149000278

€ 2,43 M.O.: 1

melchioni
mcc

CAVETTI TV SAT



Cavetto TV IEC/IEC

ARTICOLO	CONNETTORI	LUNG.	COLORE	CONF.	M.O.	PREZZO €
149000177	presa/spina	1,5 mt	bianco	blister	1	2,43
149000195	presa/spina	1,5 mt	bianco	bulk	1	1,04
149000196	presa/spina	1,5 mt	nero	bulk	1	1,04
149000273	presa/spina	1,5 mt	bianco	Polybag	1	1,51
149000275	presa/spina	3 mt	bianco	Polybag	1	2,24
149000277	spina/spina	1,5 mt	bianco	Polybag	1	1,51



CAVI TV SAT

* Cavi certificati CPR U.E. 305/2011

* Cavo coassiale digitale CLASSE A+ confezione pull box



ARTICOLO	TIPO	M.O.	PREZZO €
559576113	ZDA + 5.0 (5.0mm)	150	0,510
559576114	ZDA + 6.1 (6.1 mm)	100	0,770
559576115	ZDA + 6.8 (6.8 mm)	100	0,810

* Cavo coassiale digitale CLASSE A confezione pull box



ARTICOLO	TIPO	M.O.	PREZZO €
559576101	ZDA - 5.0 (5.0 mm)	150	0,420
559576102	ZDA - 6.1 (6.1 mm)	100	0,720
559576103	ZDA - 6.8 (6.8 mm)	100	0,750

* Cavo antenna coassiale digital CLASSE A in matassa 100mt 5mm, confezione box



ARTICOLO	CONDUTTORE	M.O.	PREZZO €
559576125	CCS	100	0,360
559576126	CU	100	0,400

* Cavo coassiale digitale CLASSE B confezione box



ARTICOLO	TIPO	M.O.	PREZZO €
559576110	ZDB - 5.0 (5.0 mm)	100	0,250
559576111	ZDB - 6.1 (6.10 mm)	100	0,340
559576112	ZDB - 6.8 (6.8 mm)	100	0,430



Cavo antenna coassiale digital CLASSE A **IRRADIO** in matassa c/connettore F 5mm

ARTICOLO	LUNGHEZZA	M.O.	PREZZO €
559576127	10 mt	1	8,88
559576128	30 mt	1	15,60
559576129	50 mt	1	25,47



* Cavo ZDSK-5,0 COAX RG59 5.0mm CLASSE A



Certificato SKY

Art. 559576120

€ 0,490

M.O.: 200



Spina F Volante con O-Ring CT7387

ARTICOLO	MISURA Ø (MM)	M.O.	PREZZO €
492515767	4.5 / 5.0 mm	200	0,360
492515768	5.8 / 6.2 mm	200	0,360
492515769	6.5 / 6.8 mm	200	0,270



Connettori F barattolo da 100pz

ARTICOLO	DESCRIZIONE	M.O.	PREZZO €
559576515	CON. F 4,4mm C/ORING	1	39,17
559576516	CON. F 5mm C/ORING	1	42,02
559576517	CON. F 6mm C/ORING	1	42,87
559576518	CON. F 6,8mm C/ORING	1	43,52
559576519	CON. PRESA / PRESA	1	35,37



TELECOMANDI UNIVERSALI

Non necessitano di programmazione o del telecomando originale e possono essere utilizzati su tv di diverse marche senza necessità di switchare da una marca all'altra!



IR-SMART 20IN1+
Telecomando dedicato
20 in 1, Pronto all'uso
Alim.: 2x 1,5V – AAA
(non include)
Dimensioni: 205 x 47 x
23 mm
Peso: 67gr

Art. 559535120
€ 7,90 M.O.: 1



IR-SMART Easy 7IN1
Telecomando dedicato
7 in 1, Pronto all'uso
Alim.: 2x 1,5V – AAA
(non include)
Dimensioni: 35 x 13 x
160 mm
Peso: 90 gr

Art. 559535137
€ 7,13 M.O.: 1



IR-SMART 7IN1+
Telecomando dedicato
7 in 1, Pronto all'uso
Alim.: 2x 1,5V – AAA
(non include)
Dimensioni: 234 x 47 x
234 mm
Peso: 95gr

Art. 559535121
€ 7,52 M.O.: 1



IR-SMART 5IN1+
Telecomando dedicato,
5 in 1, Pronto all'uso
Alim.: 2x 1,5V – AAA
(non include)
Dimensioni: 215 x 48 x
17mm
Peso: 86gr

Art. 559535122
€ 6,77 M.O.: 1

**SAMSUNG/LG/PHILIPS/SONY/
PANASONIC/SHARP/TOSHIBA/
HISENSE/SKYWORTH/VESTEL/
TELEFUNKEN/THOMSON/TCL/
GRUNDIG/HAIER/JVC/OKI/
BEKO/DAEWOO/HITACHI**

**SAMSUNG, LG, PHILIPS, SONY,
PANASONIC, HISENSE, TOSHIBA**

**SAMSUNG, LG, PHILIPS, SONY,
PANASONIC, SHARP, TOSHIBA**

**SAMSUNG, LG, PHILIPS, SONY,
PANASONIC**

TELECOMANDI DEDICATI PER TV

Prodotti pronti all'uso, non necessitano di programmazione
Sono disponibili tutte le principali funzioni dei telecomandi originali
(* adatti per tutti i modelli di Smart TV delle marche indicate, prodotti dal 2000 fino ad oggi
tastiera a tasti morbidi , alimentazione: 2 batterie AAA (non include)



SAMSUNG

IR-RCSA+
Dim.: 185 x 45 x 21mm
Peso: 68gr

Art. 559535123
€ 5,65 M.O.: 1



LG

IR-RCLG+
Dim.: 180 x 46 x 23mm
Peso: 64gr

Art. 559535124
€ 5,65 M.O.: 1



PHILIPS

IR-RCPH+
Dim.: 215 x 50 x 22mm
Peso: 92gr

Art. 559535125
€ 5,65 M.O.: 1



SONY

IR-RCSA+
Dim.: 175 x 45 x 20mm
Peso: 69gr

Art. 559535126
€ 5,65 M.O.: 1



PANASONIC

IR-RCPN+
Dim.: 220 x 50 x 23mm
Peso: 94gr

Art. 559535127
€ 5,65 M.O.: 1



HISENSE

IR-RCHS+
Dim.: 217 x 48 x 20mm
Peso: 85gr

Art. 559535128
€ 5,65 M.O.: 1



TOSHIBA

IR-RCTB+
Dim.: 245 x 52 x 22mm
Peso: 106gr

Art. 559535129
€ 5,65 M.O.: 1



SHARP

IR-RCSH+
Dim.: 210 x 50 x 20mm
Peso: 87gr

Art. 559535130
€ 5,65 M.O.: 1

TELECOMANDI DEDICATI CON COMANDO VOCALE

NOVITA' PRODOTTO

Telecomandi dedicati con comando vocale e connessione Wireless.

Funzionano subito senza programmazione: è sufficiente inserire le batterie e sono già pronti all'uso!
Estetica uguale ai telecomandi originali.

IRRADIO
Play the future



IR-RCSA-BTV

Telecomando con comando vocale

Dim.: 145 x 40 x 15mm
Peso: 43gr

SAMSUNG

Art. 559535142

€ 17,81 M.O.: 1



IR-RCLG-BTV

Telecomando con comando vocale e puntatore mouse

Dim.: 190 x 42 x 30mm
Peso: 101gr

LG

Art. 559535143

€ 23,75 M.O.: 1



IR-RCSO-BTV

Telecomando con comando vocale

Dim.: 230 x 45 x 15mm
Peso: 99gr

SONY

Art. 559535144

€ 25,72 M.O.: 1

SEMPLIFICATI UNIVERSALI



STICK

Telecomando universale autoapprendente, elegante ed intuitivo. La programmazione richiede meno di un minuto. Ideale per il settore alberghiero. Dimensioni (A x L x P): 174 x 28 x 15mm
Peso: 104gr

Art. 559535139

€ 6,34 M.O.: 1



IR-RC Easy Key

Telecomando semplificato universale, con tasti principali per la navigazione TV e numerici. Alimentazione: 2x 1,5V – AAA (non incluse) | Dimensioni: 135 x 45 x 20mm | Peso: 40gr

Richiede il telecomando originale funzionante per essere programmato.

Art. 559535111

€ 8,19 M.O.: 1

DEDICATO SKY



IR-RCSKY PRO

Telecomando dedicato compatibile con decoder SKY: Sky / Sky HD / My Sky / Sky Q

Pronto all'uso
Alim.: 2x 1,5V – AAA (non incluse)
Dimensioni: 195 x 48 x 25mm
Peso: 67gr

Art. 559535109

€ 9,87 M.O.: 1

TELECOMANDI PROGRAMMABILI DA PC

melchioni
mcc

Elite: Telecomandi programmabili a 2 e 4 banche di memoria

ELITE 2:1 2 banche di memoria
ELITE 4:1 4 banche di memoria

necessitano di programmatore cod. 559535019 (da acquistare separatamente)

ARTICOLO	MODELLO	M.O.	PREZZO €
559535060	ELITE 2:1	1	8,44
559535061	ELITE 4:1	1	8,44



TELECOMANDI UNIVERSALI PER CONDIZIONATORI

IRRADIO
Play the future



IR-AIR LX PRO II
5000 codici memorizzati

Art. 559535135
€ 11,89 M.O.: 1



IR-AIR Slim Delux

Art. 559535136
€ 9,89 M.O.: 1



AIR CO
1000 codici memorizzati

Art. 559535102
€ 12,83 M.O.: 1

RADIOCOMANDI

Verifica sul sito www.melchioni-ready.com le frequenze programmabili!

melchioni
mkc

NOVITA' PRODOTTO



MK-RC-FIX
Radiocomando universale
autoapprendente
frequenza fissa 433Mhz

Art. 559540150
€ 8,93 M.O.: 1

NOVITA' PRODOTTO



MK-RC-ROL
Radiocomando universale
autoapprendente frequenza fissa
+ Rolling code

Art. 559540151
€ 15,83 M.O.: 1



MK-RC-N8GB
Radiocomando universale
433Mhz 4Ch

Art. 559540135
€ 7,81 M.O.: 1



MK-RC-N8WB
Radiocomando multifrequenza
solo codice fisso, a 4 canali

Art. 559540137
€ 12,69 M.O.: 1



MK-URCRX2N8GB
Kit attuatore da interno
433Mhz 2Ch c/2 radiocomandi

Art. 559540138
€ 27,45 M.O.: 1



MK-URCRX2WN8BB
Kit attuatore da esterno
433Mhz 2Ch c/2 radiocomandi

Art. 559540140
€ 34,87 M.O.: 1

GUSCI SALVA TELECOMANDO UNIVERSALI

Salvatelecomandi in gomma
elastica estensibile
Conf. blister

IRRADIO
Play the future



IR-1925 LONG
Dimensioni telecomando:
- Larghezza: min 4 cm / max 7 cm
- Lunghezza: min 19 cm / max 25 cm

Art. 559535015
€ 9,07 M.O.: 1

IR-1419 SMALL
Dimensioni telecomando:
- Larghezza: min 3,5 cm / max 5,5 cm
- Lunghezza: min 14 cm / max 19 cm

Art. 559535016
€ 9,07 M.O.: 1

GUSCI SALVA RADIOCOMANDO UNIVERSALI

melchioni
mkc

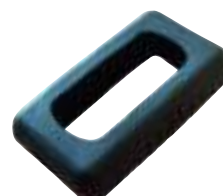

Art. 559540145
€ 9,44 M.O.: 1

MK-5512 MICRO
Salvaradiocomando universale
in gomma elastica estensibile
Conf. blister da 2 pezzi
in colori assortiti

Dimensioni radiocomando:
- Larghezza: min 2,8 cm / max 5 cm
- Lunghezza: min 5,5 cm / max 12 cm



SENSORI MKC

MKC-127A

Sensore fumo stand alone

Rileva il fumo negli ambienti interne avvisa tempestivamente di eventuali pericoli emettendo un segnale d'allarme forte e penetrante (85dB). Ideale per il montaggio a soffitto in soggiorno, camera da letto, corridoi. Dotato di pulsante di test. Assicuratevi che il vostro dispositivo funzioni regolarmente testandolo.
Confezione: scatola appendibile.



Art. 559594001
€ 11,66 M.O.: 1



Conforme
EN 14604:2005/AC:2008

MKC-208A

Rilevatore monossido di carbonio

Dispositivo progettato per rilevare la presenza di monossido di carbonio CO in ambiente residenziale tramite allarme acustico. Integra un sensore elettrochimico con elevata sensibilità e prestazioni stabili con ottima capacità anti-interferenza. Grazie alle dimensioni ridotte può essere facilmente installato.
Confezione: scatola appendibile.



Art. 559594002
€ 33,36 M.O.: 1



Conforme BS EN 50291-1

MKC-109B

Rilevatore di gas gpl + metano

Ideale per installazione a parete, rileva la presenza di gas metano e GPL, avvisando tramite un segnale acustico (sirena da 85 dB) e visivo. Dotato di pulsante TEST per la verifica periodica del corretto funzionamento del sensore. Durata del sensore: 5 anni dalla prima installazione.



Art. 559594003
€ 25,46 M.O.: 1



Conforme EN 50194-1:2009

MC-6

Alcool tester con display digitale

Etilometro per la misurazione accurata dei livelli di concentrazione di alcool nel sangue. Questo etilometro professionale è piccolo e portatile; si spegne automaticamente 10 secondi dopo il completamento del test per risparmiare energia e ha un indicatore del livello della batteria. Viene fornito con 5 inalatori sostituibili, lavabili e riutilizzabili.
Confezione: scatola



SEMPLICE

FACILE DA LEGGERE

ACCURATO

Art. 530134691
€ 18,77 M.O.: 1

Il nostro Alcool Tester ti aiuta a capire se sei pronto per la strada. Preciso, compatto e facile da usare.
Non rischiare, controlla prima di guidare!





Scarica l'applicazione Hom-io per IOS e Android e scopri l'intera gamma di prodotti che renderanno la tua casa Smart



ILLUMINAZIONE

Lampadine smart WiFi E27 10W 1050 lm

ARTICOLO	MODELLO	TIPOLOGIA	M.O.	PREZZO €
559593001	HOM-BULB-RGBW	RGBW	1	16,53
559593002	HOM-BULB-DINW	bianco din. 2700-6500 K	1	16,10



RGBW

luce bianca dinamica

Lampadine WiFi Filamento E27 7W 806 lm

ARTICOLO	MODELLO	M.O.	PREZZO €
559593065	HOM-FILBULB E27 - W4000K	1	12,77
559593070	HOM-FILBULB E27 - W2700K	1	12,77



HOM-SPOT-DINW
Faretto smart WiFi GU10
2700K-6500K 5W 400 lm 110°

Art. 559593003
€ 15,24 M.O.: 1

luce bianca dinamica



HOM-WIFI-ADAPTER
Adattatore WiFi E27
Pot. max: filam. 40W / LED 60W

Art. 559593010
€ 20,82 M.O.: 1

dimmer



HOM-CTRL-STRIP
Controller WiFi striscia
LED RGBW 12V e 24V

Art. 559593005
€ 19,96 M.O.: 1

RGBW



Il più piccolo switch presente sul mercato

Moduli Switch 1/2 canali e Dimmer

Trasforma uno/due punti luce o dispositivi tradizionali in wireless, anche dimmer. Mantiene le funzioni interruttore / dimmer. Controllo con smartphone anche in remoto.

ARTICOLO	MODELLO	M.O.	PREZZO €
559593050	HOM-MOD-SWITCH	1	24,46
559593051	HOM-MOD-DUAL 16A	1	24,26
559593056	HOM-MOD-SWITCH2	1	27,85
559593058	HOM-MOD-DIM-V2	1	25,49

HOM-LUX
Sensore luminosità intelligente (Luxmetro) Hom-io, permette di interagire con la domotica smart grazie alla rilevazione della luminosità ambientale.



Art. 559593100
€ 47,00 M.O.: 1

Intervallo Lux: 0-1000 LUX
Livello di rilevamento: 1-5 gradi
Modulo di rilevamento: fotodiode

AUTOMAZIONE

Prese WiFi con monitoraggio dei consumi
Accedi e controlla i tuoi elettrodomestici o lampade direttamente dal tuo smartphone anche fuori casa



ARTICOLO	MODELLO	M.O.	PREZZO €
559593015	HOM-PLUG +POWER bipasso	1	23,34
559593018	HOM-PLUG +POWER 16A IP44	1	25,71

Telecomandi universali IR WiFi
Accedi e controlla i tuoi dispositivi IR infrarosso direttamente dal tuo smartphone anche fuori casa



ARTICOLO	MODELLO	M.O.	PREZZO €
559593021	HOM-IR REMO-TEPRO	1	25,48
559593022	HOM-IR REMOTE display	1	40,67

HOM-PIR-PLUS
Sensore WiFi PIR
Temperatura e umidità
Distanza max rilevamento: 10m



Art. 559593090
€ 49,03 M.O.: 1



HOM-PIR
Sensore PIR Smart WiFi
Dist. max rilevamento: 7m
Dist. max WiFi: 45m
Batteria inclusa

Art. 559593016
€ 36,16 M.O.: 1



HOM-DOOR-SENSOR
Contatto porte Smart WiFi
Dist. max WiFi: 45m
Batteria inclusa

Art. 559593017
€ 27,60 M.O.: 1

HOM-TEMP-HUMIDITY
Sensore di temperatura e umidità
compatibile con Google & Alexa
(wifi, bluetooth, hotspot)



Art. 559593023
€ 21,38 M.O.: 1



HOM-POP-KIT
Kit di comando scenari, dispositivi e automazioni
con tecnologia Bluetooth
Kit: Gateway WiFi-Bluetooth + tasto multifunzione a batteria ricaricabile
Pop-button singolo acquistabile separatamente



ARTICOLO	MODELLO	M.O.	PREZZO €
559593105	HOM-POP-KIT	1	66,35
559593110	HOM-POP	1	28,05



HOM-MOD-CURTAIN
Modulo tende
e tapparelle

Trasforma in WiFi e controlla
tapparelle e tende motorizzate
in remoto tramite APP
Supporta anche un comando
a pulsante interbloccato

Art. 559593057
€ 27,78 M.O.: 1

TERMOREGOLAZIONE



HOM-TERMO-PLUS
Cronotermostato Smart WiFi
Programmazione settimanale ciclica
Nuovo ampio display completamente touch-screen
Scatola di montaggio 503 inclusa

Art. 559593047
€ 113,45 M.O.: 1

HOM-KIT-TERMOV2
Kit Testa termostatica + gateway.
Permette un risparmio maggiore
sui costi energetici e rende
la tua vita confortevole

Art. 559593082
€ 128,75 M.O.: 1



HOM-TERMOV2
Testa termostatica aggiuntiva
per il kit 559593082

Art. 559593081
€ 66,52 M.O.: 1

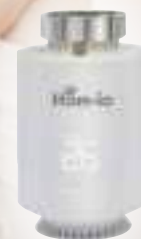

SICUREZZA



NOVITA' PRODOTTO

IR-WINCAM 3.0
Telecamera da finestra 3Mpx
Adatta per installazioni da interno, si fissa facilmente al vetro e permette di monitorare l'esterno in tempo reale anche di notte grazie alla chiara visuale notturna.

Art. 559593073
€ 45,33 M.O.: 1



HOM-BATT-CAM
Telecamera a batteria Wi-Fi
1080P - IP65 - Capacità 9600 mAh Sensore PIR e AI, registrazione su micro SD e Cloud, può funzionare completamente a batteria oppure collegata alla rete elettrica.

Art. 559593063
€ 126,29 M.O.: 1

HOM-SMARTEYE-5.0
Telecamera WiFi 1080p Full HD
Rilevamento movimento e rilevamento audio registrazione su micro SD Card (128Gb) e Cloud audio bidirezionale.



Art. 559593064
€ 62,07 M.O.: 1

HOM-OUTDOOR3
Telecamera WiFi da esterno 3.0Mpx
Optica grandangolare per una visuale ampia, 2.8mm, audio bidirezionale.



Art. 559593066
€ 54,17 M.O.: 1

HOM-SMARTEYE 3in1
Telecamera WiFi 4.0 Mpx
Motorizzata da esterno / interno Installazione a soffitto, parete, tavolo.



Art. 559593068
€ 75,94 M.O.: 1

HOM-BATT-PTZ
Telecamere PTZ in versione WIFI e G4 da 3Mpx e pannello solare per loro ricarica
Le telecamere di sicurezza da esterno sono dotate di 3 batterie 18650 e, collegate al pannello solare (venduto separatamente) sono completamente autonome



ARTICOLO	MODELLO	DESCRIZIONE	M.O.	PREZZO €
559593069	HOM-BATT-PTZ	Telecamera PTZ WIFI	1	153,06
559593071	HOM-BATT-PTZ4G	Telecamera PTZ G4	1	199,88
559593072	HOM-SOLAR-3.5	Pannello solare 3,5W 5V	1	17,63

Compatibile con valvola solenoide DN15



HOM-SMOKE
Sensore Fumo e temperatura
2 batterie CR2-3V
Possibile integrarlo in scenari e automazioni. Potente sirena integrata.

Art. 559593095
€ 49,03 M.O.: 1



IR-CO
Sensore monossido di carbonio smart
1 batteria CR123A
Possibile integrarlo in scenari e automazioni. Allarme acustico e luminoso.

Art. 559593096
€ 39,58 M.O.: 1

NOVITA' PRODOTTO



IR-GAS
Sensore gas smart
Alimentazione 230V
Possibile integrarlo in scenari e automazioni. Allarme acustico e luminoso.

Art. 559593097
€ 31,25 M.O.: 1

NOVITA' PRODOTTO



HOM-WIREBELL
Kit Videocitofono WiFi 4 fili 1080P, 2Mpx Full HD
KIT composto da 1 unità interna touch screen e 1 unità esterna IP65, collegamento semplice con i connettori pre cablati e fili predisposti alla connessione. Espandibile fino a 6 unità interne e 2 esterne.

ARTICOLO	MODELLO	DESCRIZIONE	M.O.	PREZZO €
559593130	HOM-WIREBELL	Kit Videocitofono WiFi	1	462,23
559593135	HOM-WIREBELL-SCREEN	Unità interna aggiuntiva	1	364,17
559593140	HOM-WIREBELL-STATION	Unità esterna aggiuntiva	1	128,88

ANTINTRUSIONE



HOM-OMNI ALARM
Omni Alarm Kit
Design elegante e moderno con pannello touch screen. Sirena da 90 dB
Batteria di backup da 12h

Art. 559593025
€ 160,53 M.O.: 1



Serie completa d'accessori per Omni Alarm Kit



ARTICOLO	MODELLO	M.O.	PREZZO €
1	HOM-Omni-V+M	1	39,14
2	HOM-Omni-PIR	1	36,82
3	HOM-Omni-Strobe	1	129,42
4	HOM-Omni-M	1	27,56
5	HOM-Omni-MS	1	50,72
6	HOM-Omni-Remote	1	17,37
7	HOM-Omni-EXT	1	90,28
8	HOM-Omni-Tast	1	69,24
9	HOM-Omni-Tag	1	5,79

SMART GARDENING

IR-DRIP

Kit di irrigazione smart da interno

Controlla la gestione dell'irrigazione da remoto tramite APP, tempo d'irrigazione e volume d'acqua regolabili, supporta fino a 10 vasi

Art. 559593200
€ 39,58 M.O.: 1



IR-SPRINKLER

Centralina per irrigazione smart con misuratore consumi

Utilizzabile all'esterno e controllabile tramite APP, permette di impostare un sistema di irrigazione intelligente giornaliero ripetibile ciclicamente

Art. 559593201
€ 49,47 M.O.: 1



IR-SOIL

Sensore umidità terreno smart da esterno

Permette di rilevare i parametri del terreno quali umidità e temperatura, integrabile in un sistema di irrigazione smart per automatizzare l'irrigazione

Art. 559593202
€ 33,64 M.O.: 1



IR-RAIN

Sensore pioggia smart

Sensore di rilevamento pioggia smart WiFi, integrabile nei sistemi di irrigazione smart per evitare sprechi d'acqua in caso di pioggia

Art. 559593203
€ 28,71 M.O.: 1



SECURITY

Rilevamento delle intrusioni - Starter Kit

ARTICOLO	MODELLO	DESCRIZIONE	COLORE	M.O.	PREZZO €
559591455	StarterKit ASP	Hub + MotionProtect + DoorProtect + SpaceControl	nero	1	483,54
559591454	StarterKit ASP		bianco	1	483,54
559591523	StarterKit Cam ASP	Hub 2 + MotionCam + DoorProtect + SpaceControl	bianco	1	636,00



Pannelli di controllo

ARTICOLO	MODELLO	DESCRIZIONE	COLORE	M.O.	PREZZO €
559591526	Hub 2 ASP	Unità centrale del sistema di sicurezza con supporto di foto-verifica degli allarmi (2xSIM 2G, Ethernet)	nero	1	361,00
559591525	Hub 2 ASP		bianco	1	361,00
559591633	Hub 2 Plus (8/ECG) ASP	Centrale di controllo avanzata che supporta la foto-verifica degli allarmi (2xSIM, 4G/3G/2G, Ethernet, Wi-Fi)	nero	1	617,00
559591632	Hub 2 Plus (8/ECG) ASP		bianco	1	617,00



Rilevatori di apertura

ARTICOLO	MODELLO	DESCRIZIONE	COLORE	M.O.	PREZZO €
559591536	DoorProtect ASP	Rilevatore di apertura magnetico wireless	nero	1	66,46
559591535	DoorProtect ASP		bianco	1	66,46
559591574	DoorProtect Plus ASP	Rilevatore di apertura magnetico wireless, con sensore d'urto, apertura e inclinazione	nero	1	98,54
559591573	DoorProtect Plus ASP		bianco	1	98,54



Rilevatori di rottura vetri

ARTICOLO	MODELLO	DESCRIZIONE	COLORE	M.O.	PREZZO €
559591542	CombiProtect ASP	Rilevatore di movimento e di rottura vetri wireless, ignora gli animali domestici	nero	1	133,00
559591541	CombiProtect ASP		bianco	1	133,00
559591537	GlassProtect ASP	Rilevatore di rottura vetri wireless	bianco	1	93,00



Rilevatori di movimento

ARTICOLO	MODELLO	DESCRIZIONE	COLORE	M.O.	PREZZO €
559591640	DualCurtain Outdoor ASP	Rilevatore di movimento wireless a tenda doppio fascio da esterno con anti-mascheramento e immunità agli animali domestici	bianco	1	363,23
559591522	MotionProtect Curtain ASP	Rilevatore di movimento a tenda, wireless da interno	bianco	1	130,63



Rilevatori di incendio

ARTICOLO	MODELLO	DESCRIZIONE	COLORE	M.O.	PREZZO €
559591680	FireProtect ASP	Rilevatore wireless di fumo con sensore di temperatura, sirena integrata	nero	1	114,00
559591563	FireProtect 2 RB (Heat/Smoke) ASP	Rilevatore di fumo e calore	nero	1	126,00
559591562	FireProtect 2 RB (Heat/Smoke) ASP		bianco	1	126,00
559591687	FireProtect 2 RB (CO) ASP	Rilevatore di CO	bianco	1	169,00



Scarica l'applicazione **RXCamView** per **IOS** e **Android** e scopri come gestire i tuoi prodotti **MKC True Vision**



DVR 5IN1 5MPX



**Audio + Allarmi
Notifiche Push**

**DVR 5 MPX a 4, 8, 16 Canali
Ibrido, Protocollo H265 con Audio e Allarmi**

ARTICOLO	MODELLO	INGRESSI	M.O.	PREZZO €
559590970	MKC TrueV 5MP 4CH+	4	1	128,49
559590971	MKC TrueV 5MP 8CH+	8	1	193,82
559590972	MKC TrueV 5MP 16CH+	16	1	346,29

TELECAMERE 4IN1 5MPX - 2MPX

**Telecamere
5Mpx e 2Mpx 4in1
ottica varifocal
case in metallo**



ARTICOLO	CAMERA	OTTICA	M.O.	PREZZO €
559590989	mini dome 5mpx	3,6mm	1	54,46
559590987	mini bullet 5mpx		1	54,46
559590990	dome 5mpx	2,8-12mm	1	94,74
559590988	bullet 5mpx		1	94,74

ARTICOLO	CAMERA	OTTICA	M.O.	PREZZO €
559590983	mini dome 2mpx	3,6mm	1	49,03
559590981	mini bullet 2mpx		1	47,91
559590984	dome 2mpx	2,8-12mm	1	81,66
559590982	bullet 2mpx		1	80,60

TELECAMERE 4IN1 2MPX - SERIE ECO



MKTV-DF2MPEco
Telecamera mini dome 2Mpx
4 in 1, ottica 3,6mm varifocal
case in plastica

Art. 559590986
€ 31,57 M.O.: 1



MKTV-BF2MPEco
Telecamera mini bullet 2Mpx
4 in 1, ottica 3,6mm varifocal
case in plastica

Art. 559590985
€ 31,57 M.O.: 1

STAFFE



MKTV-SBDF
Staffa per telecamere bullet e dome
in versione ottica fissa
φ100.5mm H: 56mm

Art. 559590991
€ 16,91 M.O.: 1



MKTV-SBDV
Staffa per telecamere bullet e dome
in versione ottica varifocale
φ134.3mm H: 59mm

Art. 559590992
€ 16,91 M.O.: 1

BALUN



**Convertitore video
balun 4 in 1
Analog-AHD-TVI-CVI**

*Prezzo valido
per la coppia*

Art. 559590148
€ 7,61 M.O.: 1



**Coppia TX-RX
video balun 4in1
UHD 4K**

Art. 559590151
€ 5,61 M.O.: 1



**Coppia TX-RX
video balun 4in1
HD 5Mpx**

Art. 559590150
€ 4,15 M.O.: 1



VIDEOSORVEGLIANZA



MONITOR LED

Staffa da tavolo inclusa
Alimentazione 12 vcc 3a
Alimentatore 230 Vca incluso
IRC215 21,5" HDMI - VGA - BNC

Art. 559591028

€ 428,95 M.O.: 1



CAVI ALLARME

Gamma Cavi allarme con guaina PVC

Cavi per sistemi di sicurezza, schermati con nastro AI/PET, senza alogeni.



ARTICOLO	MODELLO	CONDUTTORE	MARCATURA	M.O.	PREZZO €
492329190	MK-222.CU	CU	2 x 0.22 mm ²	100	0,360
492329192	MK-222.CCA	CCA		100	0,190
492329191	MK-422.CU	CU	4 x 0.22 mm ²	100	0,580
492329193	MK-422.CCA	CCA		100	0,270
492329194	MK-205.222.CU	CU	2 x 0.50 mm ² + 2 x 0.22 mm ²	100	0,800
492329196	MK-205.222.CCA	CCA		100	0,400
492329195	MK-205.422.CU	CU	2 x 0.50 mm ² + 4 x 0.22 mm ²	100	0,940
492329197	MK-205.422.CCA	CCA		100	0,490

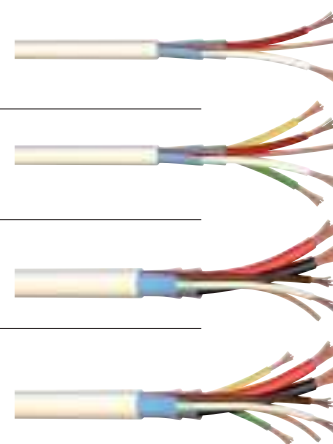

Cavo professionale per sistemi d'allarme bianco con schermatura grado 3



ARTICOLO	MODELLO	MARCATURA	SEZ. NOM (MM ²)	M.O.	PREZZO €
492329164	MKC622	6 X 022	0,22	100	0,540
492329165	MKC822	8 X 022	0,22	100	0,600
492329168	MKC6225	6x022 + 2x050	6x0,22 / 2x0,50	100	1,070

CAVI PER VIDEOCONTROLLO

ARTICOLO	MODELLO	SEZ. NOM. (MM ²)	M.O.	PREZZO €
492329159	MKCTVCC22	2 x 0,22	100	1,220
492329160	MKCTVCC50	2 x 0,50	100	1,530



Cavo nero RG59 TVCC 1x075 Ohm conduttore CU in matassa da 100mt

Fascia PRO

Ricetrasmittitori palmari PMR 446 8ch



K6

- 8 canali banda PMR 446
- Potenza di trasmissione 0,5W
- Batteria agli ioni di litio 7,4 V2.000 mAh
- Display digitale grafico retroilluminato
- 32 Canali su 16 Frequenze
- 7 Canali utility

Art. 531811771
€ 167,52 M.O.: 1



K5

- 8 canali banda PMR 446
- Potenza di trasmissione 0,5W
- Batteria agli ioni di litio 7,4 V2.000 mAh
- Display sottoscocca

Art. 531811756
€ 167,76 M.O.: 1



Fascia PRO Easy

Ricetrasmittitori palmari PMR 446 8ch



K4

- 8 canali banda PMR 446
- Potenza di trasmissione 0,5W
- Batteria agli ioni di litio 4,2V 1.000 mAh
- Display digitale grafico retroilluminato
- 32 Canali su 16 Frequenze
- 7 Canali utility

Art. 531811772
€ 84,79 M.O.: 1



K3

- 8 canali banda PMR 446
- Potenza di trasmissione 0,5W
- Batteria agli ioni di litio 3.7 V 2200mAh
- Display sottoscocca

Art. 531811751
€ 95,38 M.O.: 1

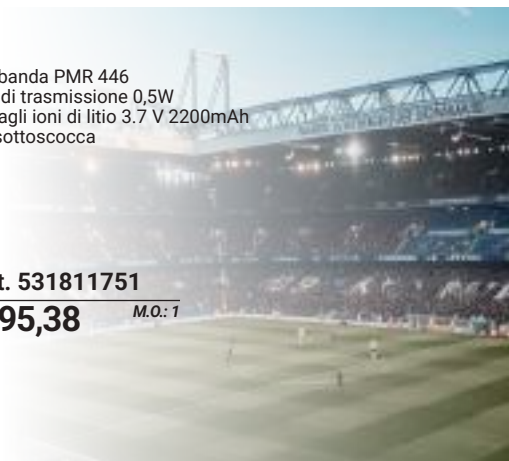

Fascia Consumer

IRRADIO
Play the future



Kit doppio ricetrasmittitore palmare PMR446 8ch plug&play

IR-TX446 FreeWave

- 8 canali banda PMR 446
- Potenza di trasmissione 0,5 Watt
- Batteria agli ioni di litio 4,2 Volts 1.000 mAh
- Squelch automatico

Art. 531811773
€ 101,34 M.O.: 1



Microfono auricolare ad uncino per K2 / K2000 / K3 / K5

Art. 539723338
€ 10,12 M.O.: 1



Microfono auricolare per K4 - K6 IR-TX446 FreeWave

Art. 531811781
€ 12,42 M.O.: 1



MKC linea Interactive

La linea UPS MK è la gamma ideale per la protezione completa da blackout e sbalzi di tensione. Ideale per il funzionamento continuo di tutte le apparecchiature domestiche e per ufficio quali Computer, DVR/NVR e sistemi video sorveglianza, Modem adsl/fibra, switch/router, registratori di cassa.

- Circuito elettronico di stabilizzazione tensione AVR
- Sistema di riaccensione e ricarica automatica
- Prese d'uscita protette da blackout
- Prese d'uscita protette da sovratensioni
- Basso livello di rumorosità



ARTICOLO	MODELLO	POTENZA NOMINALE	POTENZA ATTIVA	M.O.	PREZZO €
480820001	MK-650UPS	650 VA	360 W	1	67,27
480820002	MK-800UPS	800 VA	480 W	1	79,51
480820003	MK-1200UPS	1200 VA	600 W	1	141,67
480820004	MK-1500UPS	1500 VA	900W W	1	172,83



I nuovi prodotti TOGHETER ON costituiscono la linea Ecologica a basso consumo. Cercali nella gamma!

UPS ERA PLUS DC 9VDC/12VDC POE 15VDC/24VDC - USB 5VDC TOGETHER ON

Mini UPS dalle dimensioni compatte e prestazioni professionali. Ideale per l'alimentazione di dispositivi come WiFi, Router, Modem, VOIP, Telecamera e la ricarica di Tablet, SmartPhone, Cuffie Bluetooth, Smartwatch, ecc.

- Batterie al Litio da 8.800 mAh
- Funzione POE: alimentazione aggiuntiva sul cavo LAN
- 10 connettori inclusi: compatibilità con la maggior parte dei dispositivi
- Protezione sovraccarico, cortocircuito, sovratensioni
- Controllo temperatura interna

Art. 480810220

€ 107,88 M.O.: 1



TECNOWARE linea Interactive

Gruppi di continuità con uscite schuko, stabilizzazione AVR, protezione completa da blackout e sbalzi di tensione (sovra e sotto tensioni). Fattore di potenza: 0,7. Consigliati per PC, DVR/NVR e sistemi video sorveglianza, modem adsl/fibra, switch/router, registratori di cassa. Non adatti con alimentatori con circuito PFC Attivo (Server, PC game, console videogiochi, workstation, computer Mac).

ARTICOLO	MODELLO	POTENZA NOMINALE	POTENZA ATTIVA	LINEA ECO	M.O.	PREZZO €
480810190	ERA PLUS 800	800 VA	560 W	SI	1	101,94
480810198	ERA PLUS 950	950 VA	665 W	SI	1	134,58
480810191	ERA PLUS 1200	1200 VA	840 W	SI	1	169,10
480810192	ERA PLUS 1600	1600 VA	1120 W	SI	1	275,10
480810193	ERA PLUS 2000	2000 VA	1400 W	SI	1	526,46
480810194	ERA PLUS 2600	2600 VA	1820 W	SI	1	748,13



TECNOWARE linea UPS EXA PLUS

Per workstation, PC / console game, PC, Server, Local Area Networks, home theatre, TV, HI-FI, termocamini (escluso Exa PLUS 1.100), caldaie per riscaldamento domestico. Silenzioso (la ventola lavora solo in modalità batteria o quando l'AVR è attivo) Display con Intelligent Backlighting System | 2 porte USB Charger (5V 2.1A) Circuito elettronico di stabilizzazione tensione AVR | Uscita sinusoidale Batteria Hot Swap | Prese d'uscita protette da blackout e sovratensioni Software di gestione UPS TecnoManager compatibile con Windows, Mac OS X, Unix, Linux, ecc.



ARTICOLO	MODELLO	POTENZA NOMINALE	POTENZA ATTIVA	LINEA ECO	M.O.	PREZZO €
480810208	UPS EXA PLUS 1100	1100 VA	770 W	SI	1	393,49
480810209	UPS EXA PLUS 1600	1600 VA	1120 W	SI	1	564,11
480810210	UPS EXA PLUS 2100	2100 VA	1470 W	SI	1	863,63

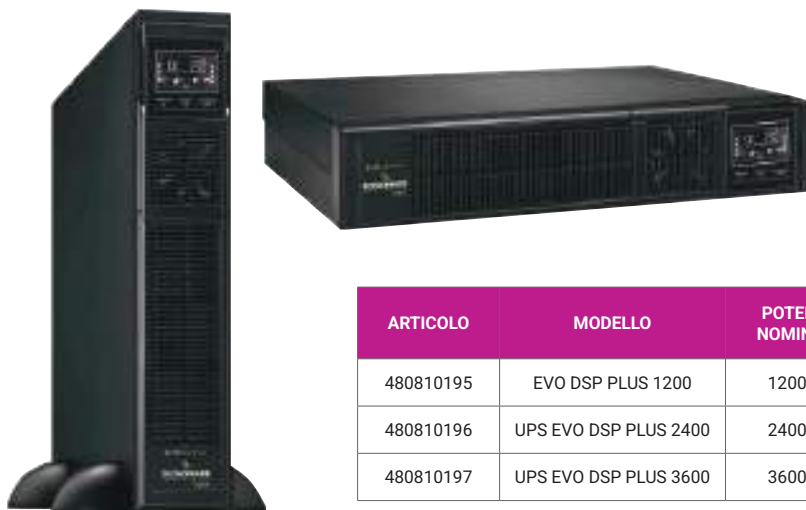

TECNOWARE linea On Line Rack/Tower

Gruppi di continuità tecnologia On Line (VFI) DSP, PF 0,9. Efficienza 94%, ingresso/uscita 230/230Vac 50/60Hz, prese uscita IEC. Protezione completa da blackout, sbalzi di tensione (sovra e sottotensioni), fulmini (con scaricatore a monte), variazioni di frequenza, surge, armoniche, distorsioni di tensione. Consigliato per Data Centers, Local Area Network (LAN), Elettromedicali, Processi industriali, Server virtuali, Stufe a pellet, Termocamini, Caldaie per riscaldamento domestico.

ARTICOLO	MODELLO	POTENZA NOMINALE	POTENZA ATTIVA	LINEA ECO	M.O.	PREZZO €
480810195	EVO DSP PLUS 1200	1200 VA	1080 W	SI	1	1.011,35
480810196	UPS EVO DSP PLUS 2400	2400 VA	2160 W	SI	1	1.375,52
480810197	UPS EVO DSP PLUS 3600	3600 VA	3240 W	SI	1	1.761,46



UPS gruppo di continuità ERA PLUS

Numero di fasi ingresso/uscita: 1F+N; Tensione nominale; Monofase 230Vac; Protezione completa da black out e sbalzi di tensione (sovratensioni e sottotensioni); Non adatto con alimentatori con circuito PFC Attivo (Server, PC game, console videogiochi, workstation, computer Mac), lampade e motori elettrici; Circuito elettronico di stabilizzazione tensione AVR; n°2 prese d'uscita Italia/Schuko ed n°1 cavo ingresso schuko; Prese d'uscita protette da blackout e sovratensioni; LED multifunzione e tasto on-off; Porta USB per il controllo/monitoraggio UPS e la programmazione di accensione/spengimento tramite il software Tecnomanager

ARTICOLO	MODELLO	POTENZA NOMINALE	POTENZA ATTIVA	LINEA ECO	M.O.	PREZZO €
491929487	ERA PLUS ACTIVE 1.200	1200 VA	840 W	SI	1	204,94
491929488	ERA PLUS ACTIVE 1.600	1600 VA	-	SI	1	272,63



UPS ERA PLUS STRIP 1000 TOGETHER ON

- Circuito elettronico di stabilizzazione tensione AVR
- Porta USB Charger (5V 2.1A)
- Batterie easy replacement
- Asole posteriori per fissaggio a parete
- Prese d'uscita con child protection protette da blackout
- Prese d'uscita con child protection protette da sovratensioni
- Porta USB
- Software di gestione UPS TecnoManager compatibile con Windows, Mac OS X, Unix, Linux, ecc.

Art. 480810199
€ 195,94 M.O.: 1

ALIMENTAZIONE UPS + PC



CAVETTO 3 POLI 10-A/IEC C13
spina/presa 1,5mt nero



CAVETTO 2 POLI 10A/IEC C7
spina/presa 1,5mt nero

ARTICOLO	CONFEZIONE	M.O.	PREZZO €
149000285	polybag	1	4,89
149000198	bulk	1	3,68

ARTICOLO	CONFEZIONE	M.O.	PREZZO €
149000286	polybag	1	3,04
149000199	bulk	1	1,96



SICUREZZA NETWORKING

BOX A MURO



MKDVR6
Box a muro **DVR/NVR 2 serrature**
(obbligo per gdpr) con ripiano apribile
550 (A) x 580 (L) x 160 (P)

Art. 486623394
€ 168,16 M.O.: 1



MKWIFIBOX01
Box per dispositivi home
con porta in vetro nera
265 (A) x 465 (L) x 122 (P)

Art. 486623414
€ 129,07 M.O.: 1



MKWIFIBOX02
Box per dispositivi home
con porta in vetro bianca
345 (A) x 345 (L) x 232 (P)

Art. 486623415
€ 77,72 M.O.: 1



MKWIFIBOX03
Box per dispositivi home
con porta in vetro bianca
265 (A) x 265 (L) x 122 (P)

Art. 486623417
€ 85,31 M.O.: 1

ARMADI RACK 19" CON PORTA IN VETRO



A



B



C



D

ARTICOLO	MODELLO	UNITÀ	TIPO	COLORE	DIMENSIONI (A x L x P) MM	M.O.	PREZZO €
486623433	MK1907UN	6	da muro	nero	350 x 540 x 450	1	149,78
486623432	MK1907UG	6	da muro	grigio	350 x 540 x 450	1	149,78
A 486623347	MK1906UNL	6	da muro, ripiano incluso	nero	300 x 530 x 400	1	100,47
486623361	MK1906UL	6	da muro, ripiano incluso	grigio	300 x 530 x 400	1	100,47
B 486623015	MK1909UG	9	da muro	grigio	485 x 540 x 450	1	160,41
486623020	MK1909UN	9	da muro, ripiano incluso	nero	450 x 530 x 400	1	160,41
486623364	MK1909UNL	9	da muro, ripiano incluso	nero	450 x 530 x 400	1	131,38
486623355	MK1909UL	9	da muro	grigio	620 x 540 x 450	1	131,38
486623099	MK1912UG	12	da muro	grigio	620 x 540 x 450	1	186,66
C 486623098	MK1912U66N	12	da muro	nero	620 x 540 x 600	1	249,31
486623350	MK1912UNL	12	da muro	nero	600 x 530 x 400	1	162,29
486623107	MK1915U66G	15	da muro	grigio	750 x 540 x 600	1	262,50
486623108	MK1915U66N	15	da muro	nero	750 x 540 x 600	1	262,50
D 486623166	MK1922U66GR	22	da terra	grigio	1.166 x 600 x 600	1	659,30
486623167	MK1922U66N	22	da terra	nero	1.166 x 600 x 600	1	659,30

SICUREZZA NETWORKING

RIPIANI PER ARMADI RACK 19"

	ARTICOLO	MODELLO	UNITÀ	TIPO	COLORE	PROFONDITÀ	M.O.	PREZZO €
A	486623254	MK RIP350N	1	universale	nero	350 mm	1	38,28
	486623243	MK RIP250N2U	2	universale	nero	250 mm	1	26,67
	486623255	MK RIP350N2U	2	universale	nero	350 mm	1	49,22
B	486623241	MK RIP250G2U	2	universale	grigio	250 mm	1	26,58
	486623242	MK RIP250N	1	universale	nero	250 mm	1	33,90
	486623251	MK RIP350G2U	2	universale	grigio	350 mm	1	49,22



LISTELLO GUIDACAVI PER ARMADI RACK 19"

MKORG1UN
1 unità 5 anelli
colore nero in metallo

Art. 486623277
€ 11,39 M.O.: 1



MULTIPRESE



Multipresa da rack 19" prese universali
con interruttore, spina italiana 16A

ARTICOLO	MODELLO	N° PRESE	MAGNETOTERMICO	M.O.	PREZZO €
486623420	MK10050	6	si	1	47,91
486623421	MK10051	8	no	1	42,66
486623422	MK10053	9	no	1	47,25
486623424	MK10060	6	no	1	39,15
486623425	MK10065	8	no	1	45,94

PANNELLI PATCH



Pannello patch non schermato UTP
24 connettori RJ45

ARTICOLO	MODELLO	CATEGORIA	M.O.	PREZZO €
486623286	MKP624U	6	1	45,94
486623095	MKP6A24U	6 A	1	74,37
486623285	MKP5E24U	5 E	1	43,31

KIT VITI DADI E RONDELLE



ARTICOLO	MODELLO	COLORE	M.O.	PREZZO €
486623224	MKKIT50VN	nero	1	20,61
486623225	MKKIT50VZ	grigio	1	20,65

CASSETTO FIBRA OTTICA



MKFO24N
Cassetto fibra ottica 24 porte
1 unità per adattatori LC duplex
e SC simplex per installazione 19"
nero con binari t

Art. 486623090
€ 107,18 M.O.: 1

VENTOLE DA RACK



MKVENT2N
Modulo 2 ventole raffreddamento
con display nero

Art. 486623294
€ 212,18 M.O.: 1



MKVENT2
Modulo 2 ventole con termostato
per armadi rack a muro link colore nero

Art. 486623291
€ 127,97 M.O.: 1



MKVENT2G
Modulo 2 ventole con termostato
per armadi rack a muro link colore grigio

Art. 486623292
€ 127,97 M.O.: 1



I cavi patch **DIGITUS®** sono realizzati e testati secondo le normative **ISO/IEC 11801** e **DIN EN 50173**.
Garantiscono che l'installazione del cavo sia conforme alle specifiche del canale ISO e offrono prestazioni eccellenti per il cablaggio.

Le prestazioni sono state testate fino a 100 MHz per la categoria 5e, 250 MHz per la categoria 6 e 500 MHz per la categoria 6A, comprese caratteristiche come la paradiafonia.

Questi prodotti sono progettati per soddisfare pienamente le esigenze delle diverse aree applicative. Ogni cavo è dotato di un salvacordone stampato con serracavo integrato.

Inoltre, la guarnizione presenta una protezione del fermo che previene l'agrovigliamento del cavo e la rottura della leva di arresto del connettore.

La categoria del cavo è facilmente identificabile grazie al colore del connettore:
blu per la categoria 5e, rosso per la categoria 6 e giallo per la categoria 6A.

CARATTERISTICHE TECNICHE

- 2x presa RJ45 (8P8C)
- Cappuccio con protezione antipiega, scarico della trazione e protezione del fermo
- Lunghezza minima di avvio
- Conduttore interno: Rame (Cu)
- Assortimento: Cavi patch a doppino intrecciato
- Configurazione: 1:1
- Imballaggio: Busta in plastica DIGITUS
- Schermatura: UTP, non schermato / FTP, schermato
- Struttura: 4 x 2 AWG 26/7, doppino

NOVITÀ

Cat5 E

GUAINA PVC COLORE GRIGIO									
LUNGHEZZA	U-UTP	M.O.	PREZZO €	SF-UTP	M.O.	PREZZO €	S-FTP	M.O.	PREZZO €
0,5 mt	486700041	1	1,44	-	-	-	486605555	1	1,79
1 mt	486700042	1	1,77	486605582	1	2,53	486605556	1	1,90
2 mt	486700044	1	2,83	-	-	-	486605557	1	2,75
3 mt	486700045	1	3,45	486605408	1	5,07	-	-	-
5 mt	486700046	1	5,76	486605409	1	6,97	-	-	-
7 mt	-	-	-	-	-	-	-	-	-
10 mt	-	-	-	-	-	-	-	-	-
15 mt	-	-	-	486605412	1	20,65	-	-	-
20 mt	486605581	1	14,91	-	-	-	-	-	-

Cat6 A

GUAINA LSZH COLORE GRIGIO						
LUNGHEZZA	U-UTP	M.O.	PREZZO €	S-FTP	M.O.	PREZZO €
0,25 mt	-	-	-	486700000	1	2,79
0,5 mt	486605570	1	2,87	486700001	1	3,60
1 mt	486605571	1	3,64	486700002	1	4,08
2 mt	486605572	1	4,85	486700003	1	6,39
3 mt	486605573	1	6,35	486700004	1	8,45
5 mt	486605574	1	9,24	486700005	1	12,52
7 mt	-	-	-	486700006	1	16,58
10 mt	486605575	1	17,80	486700007	1	23,38
15 mt	-	-	-	486700008	1	33,04
20 mt	-	-	-	-	-	-
25 mt	-	-	-	486700009	1	54,09
30 mt	-	-	-	486700010	1	60,89

Cat5 E



Cat6 A



Cat6



Cat6

GUAINA PVC COLORE GRIGIO						
LUNGHEZZA	U-UTP	M.O.	PREZZO €	S-FTP	M.O.	PREZZO €
0,5 mt	486700023	1	1,99	486700012	1	2,75
1 mt	486700024	1	2,51	486700013	1	3,28
2 mt	486700026	1	3,93	486700014	1	4,95
3 mt	486700027	1	4,61	486700015	1	6,23
5 mt	486700028	1	7,14	486700016	1	9,60
7 mt	486605420	1	9,84	486605421	1	12,96
10 mt	486700029	1	15,41	486700017	1	16,76
15 mt	486700030	1	21,92	486700018	1	23,86
20 mt	486700031	1	28,59	486700019	1	31,04

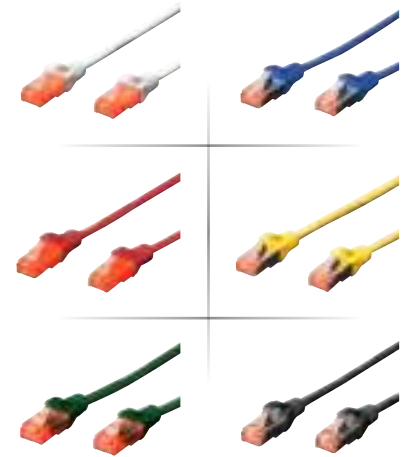

Cat6

GUAINA PVC COLORE BIANCO				COLORE BLU			COLORE ROSSO		
LUNGHEZZA	U-UTP	M.O.	PREZZO €	U-UTP	M.O.	PREZZO €	U-UTP	M.O.	PREZZO €
0,5 mt	486605425	1	1,99	486605435	1	1,99	486605445	1	1,99
1 mt	486605426	1	2,51	486605436	1	2,51	486605446	1	2,51
2 mt	486605427	1	3,93	486605437	1	3,93	486605447	1	3,93
3 mt	486605428	1	4,61	486605438	1	4,61	486605448	1	4,61
5 mt	486605429	1	7,14	486605439	1	7,14	486605449	1	7,14

LUNGHEZZA	S-FTP	M.O.	PREZZO €	S-FTP	M.O.	PREZZO €	S-FTP	M.O.	PREZZO €
0,5 mt	486605430	1	2,75	486605440	1	2,75	486605450	1	2,75
1 mt	486605431	1	3,28	486605441	1	3,28	486605451	1	3,28
2 mt	486605432	1	4,95	486605442	1	4,95	486605452	1	4,92
3 mt	486605433	1	6,20	486605443	1	6,23	486605453	1	6,20
5 mt	486605434	1	9,58	486605444	1	9,58	486605454	1	9,58

Cat6

GUAINA PVC COLORE GIALLO				COLORE VERDE			COLORE NERO		
LUNGHEZZA	U-UTP	M.O.	PREZZO €	U-UTP	M.O.	PREZZO €	U-UTP	M.O.	PREZZO €
0,5 mt	486605455	1	1,99	486605465	1	1,99	486605560	1	1,99
1 mt	486605456	1	2,51	486605466	1	2,51	486605561	1	2,51
2 mt	486605457	1	3,93	486605467	1	3,93	486605562	1	3,93
3 mt	486605458	1	4,61	486605468	1	4,61	486605563	1	4,61
5 mt	486605459	1	7,12	486605469	1	7,12	486605564	1	7,14

LUNGHEZZA	S-FTP	M.O.	PREZZO €	S-FTP	M.O.	PREZZO €	S-FTP	M.O.	PREZZO €
0,5 mt	486605460	1	2,75	486605550	1	2,75	486605565	1	2,75
1 mt	486605461	1	3,28	486605551	1	3,28	486605566	1	3,28
2 mt	486605462	1	4,95	486605552	1	4,95	486605567	1	4,90
3 mt	486605463	1	6,23	486605553	1	6,23	486605568	1	6,23
5 mt	486605464	1	9,60	486605554	1	9,58	486605569	1	9,58



CAVETTI LAN

Cavetto LAN CAT6



Cavetto LAN CAT5 FTP / UTP

ARTICOLO	SCHERMATURA	LUNGHEZZA	M.O.	PREZZO €
486605346	UTP	5 mt	1	4,08

ARTICOLO	SCHERMATURA	LUNGHEZZA	M.O.	PREZZO €
486605301	FTP	1 mt	1	1,76
486605306	FTP	2 mt	1	2,41
486605303	FTP	5 mt	1	4,76
486605342	FTP	10 mt	1	8,43
486605304	UTP	1 mt	1	1,19
486605308	UTP	5 mt	1	2,93
486605351	UTP	7 mt	1	4,37
486605352	UTP	10 mt	1	5,70
486605368	UTP	20 mt	1	7,61

CAVI LAN IN MATASSA E ACCESSORI

Gamma Cavi LAN con guaina LSZH



cavi solidi in matasse da 305 mt colore grigio

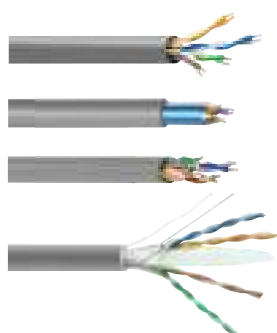

ARTICOLO	MODELLO	CATEGORIA	SCHERMATURA	CONDUTTORE	M.O.	PREZZO €
486605509	MK-5EUSCCA.305	CAT5E	UTP	CCA	305	0,330
486605501	MK-5EUSCU.305	CAT5E	UTP	CU	305	1,080
486605511	MK-5EFSCCA.305	CAT5E	FTP	CCA	305	0,390
486605503	MK-5EFSUCU.305	CAT5E	FTP	CU	305	1,310
486605513	MK-6USCCA.305	CAT6	UTP	CCA	305	0,410
486605505	MK-6USCU.305	CAT6	UTP	CU	305	1,200
486605515	MK-6FSCCA.305	CAT6	FTP	CCA	305	0,500
486605507	MK-6FSCUCU.305	CAT6	FTP	CU	305	1,450

Cavo LAN con doppia guaina PVC + LSZH

cavo solido con conduttori in rame, CPR ECA, con svolgitori in legno da 305 mt, colore nero



MK-6USCU-2G.305 CAT6 UTP
Art. 486605500
€ 0,950 M.O.: 305



Cavi Categoria 5E/6 UTP Solido in CCA
 matasse da 100 mt colore bianco

ARTICOLO	MODELLO	TIPO	M.O.	PREZZO €
486605487	MKC5EUSCCA100W	Cat 5E AWG 24	100	0,470
486605488	MKC6USCCA100W	Cat 6 AWG 23	100	0,650



Cavi Categoria 5E/6 UTP Solido in CU
 matasse da 100 mt colore bianco

ARTICOLO	MODELLO	TIPO	M.O.	PREZZO €
486605489	MKC5EUSCU100W	Cat 5E AWG 24	100	0,880
486605490	MKC6USCU100W	Cat 6 AWG 23	100	1,260



matasse da 100 a 305 mt colore grigio

ARTICOLO	MODELLO	TIPO	M.O.	PREZZO €
486605491	MKC6USCCA305LSZH	Cat 6 AWG 23 guaina SLZH	305	0,590
486605478	MKC5EUS100	Cat 5E AWG 24	100	0,370
486605479	MKC5EFS100	Cat 5E AWG 24 FTP Solido	100	0,420
486605474	MKC6US	Cat 6 AWG 23	305	0,470



matasse da 100 a 305 mt colore grigio

ARTICOLO	MODELLO	TIPO	M.O.	PREZZO €
486605480	MKC5EUSCU100	Cat 5E AWG 24	100	0,840
486605481	MKC5EUSCU305	Cat 5E AWG 24	305	0,820
486605485	MKC6USCU305	Cat 6 AWG 23	305	1,190



MKCT450
 Tester di rete RJ45 RJ11 RJ12

Art. 489905004
€ 12,37 M.O.: 1



CAVI IN FIBRA OTTICA

Cavo in fibra ottica SC/APC a SC/APC
monomodale G.657A2 Simplex LSZH

Vodafone | TIM | WindTre



ARTICOLO	MODELLO	LUNGHEZZA	M.O.	PREZZO €
149029203	IM1400	1 mt	1	4,35
149029204	IM1401	2 mt	1	4,71
149029205	IM1402	3 mt	1	4,98
149029206	IM1403	5 mt	1	5,48
149029207	IM1404	10 mt	1	6,79
149029208	IM1405	15 mt	1	8,10
149029209	IM1406	20 mt	1	9,00
149029210	IM1407	25 mt	1	10,52
149029211	IM1408	30 mt	1	11,73
149029212	IM1409	40 mt	1	13,60
149029213	IM1410	50 mt	1	16,44
149029214	IM1411	70 mt	1	21,71
149029215	IM1412	100 mt	1	29,60

Cavo in fibra ottica SC/APC a SC/UPC
monomodale G.657A2 Simplex LSZH

ILIAD



ARTICOLO	MODELLO	LUNGHEZZA	M.O.	PREZZO €
149029216	IM1420	1 mt	1	4,35
149029217	IM1421	2 mt	1	4,71
149029218	IM1422	3 mt	1	4,98
149029219	IM1423	5 mt	1	5,48
149029220	IM1424	10 mt	1	6,79
149029221	IM1425	15 mt	1	8,10
149029222	IM1426	20 mt	1	9,00
149029223	IM1427	25 mt	1	10,52
149029224	IM1428	30 mt	1	11,73
149029225	IM1429	40 mt	1	13,60
149029226	IM1430	50 mt	1	16,44
149029227	IM1431	70 mt	1	21,71
149029228	IM143	100 mt	1	29,60

CONNETTORI CAT5 / CAT6

**Spina RJ45
connettore con fori passanti**
prezzo riferito alla confezione



ARTICOLO	CATEGORIA	TIPO	CONFEZIONE	M.O.	PREZZO €
486105025	Cat 5E	FTP	barattolo 100 pezzi	1	16,34
486105026		UTP		1	11,25
486105027	Cat 6	FTP		1	18,31
486105028		UTP		1	13,27
486105029	Cat 5E	FTP	sacchetto 20 pezzi	1	2,98
486105030		UTP		1	2,08
486105031	Cat 6	FTP		1	3,38
486105032		UTP		1	2,43

**Copriconnettori
per spina RJ45**
sacchetto da 100 pezzi
prezzo riferito
alla confezione



ARTICOLO	DIMENSIONE	COLORE	M.O.	PREZZO €
486105039	6,00 mm	blu	1	13,14
486105040		giallo	1	13,14
486105041		grigio	1	13,14
486105042		nero	1	13,14
486105043		rosso	1	13,14
486105044		verde	1	13,14
486105045		viola	1	13,14
486105047	7,00 mm	blu	1	15,24
486105049		grigio	1	15,24
486105051	7,50 mm	blu	1	15,33
486105052		grigio	1	15,33



Spina RJ45 Toolless
sacchetto da 1 pezzo

ARTICOLO	CATEGORIA	SCHERMATURA	M.O.	PREZZO €
486105054	Cat5E	UTP	1	2,37
486105055	Cat6	UTP	1	2,76
486105056	Cat6A	FTP	1	6,23



Presse Keystone da pannello
sacchetto da 1 pezzo

ARTICOLO	MODELLO	TIPO	M.O.	PREZZO €
486105033	Cat 5E	RJ45 8P8C UTP	1	1,94
486105034	Cat 6		1	2,19

Accoppiatore RJ45 presa / presa
sacchetto da 3 pezzi
prezzo riferito al pezzo



ARTICOLO	MODELLO	TIPO	M.O.	PREZZO €
486105035	Cat 5E	schermato	3	3,55
486105036		non schermato	3	2,08
486105037	Cat 6	schermato	3	3,86
486105038		non schermato	3	2,19



CONNETTORI CAT5 / CAT6

Spina-mod CAT5 8/8
x cavo rigido

Art. 486105001
€ 0,150 M.O.: 200

Spine modulari CAT5 keyed

Art. 486105003
€ 0,120 M.O.: 100

Spina-mod CAT5 8/8
schermata x cavo rigido

Art. 486105005
€ 1,37 M.O.: 50

Spina-mod CAT6 8/8 schermata
per fili rigidi per cavo tondo

Art. 486105016
€ 0,620 M.O.: 10

Spina-mod CAT6 8/8
per fili rigidi per cavo tondo

Art. 486105018
€ 0,620 M.O.: 10

Spina Plug telefonico 8/8 in blister
da 4 pezzi

Art. 492821547
€ 3,56 M.O.: 20

ACCESSORI TELEFONIA

Spina telefonica plug modulare

ARTICOLO	TIPO PLUG	M.O.	PREZZO €
492821536	4/4	200	0,140
492821537	6/4	200	0,070
492821538	6/6	200	0,120
492821539	8/8	100	0,100



Filtro ADSL con spina
presa tripolare

Art. 433329835
€ 3,56 M.O.: 10



Filtro adsl 6/2
2In 1Out con RJ45 6p2c 3u

Art. 433329836
€ 2,78 M.O.: 10



Accoppiatore telefonico modulare
di giunzione in line coupler 2x8/8 8p8c RJ45

Art. 492821525
€ 1,01 M.O.: 20

Presa telefonica
modulare a muro 6/4

Art. 492821157
€ 1,66 M.O.: 10



Adattatore telefonico
mini spina-presa tripolare
con presa 6p2c

Art. 492821540
€ 2,25 M.O.: 20



Suoneria telefonica
supplementare acustica
e visiva con flash

Art. 492821550
€ 13,52 M.O.: 5



UTENSILERIA

Pinza crimpatrice
in plastica ABS per connettori
telefonici 4/4 - 6/6 - 8/8

Art. 492821553
€ 23,76 M.O.: 2

Pinza per faston
non isolati

Art. 495136599
€ 15,94 M.O.: 1

Pinza per connettori telefonici
8P8C / 6P6C / 6P4C
4P4C / 4P2C

Art. 495136633
€ 28,10 M.O.: 1

Pinza crimpatrice
professionale con vite di rilascio

Art. 495136634
€ 112,81 M.O.: 1

HT-301G
Pinza crimpatrice adatta
per cavi rg58, rg59, rg62 e rg174

Art. 495138592
€ 43,54 M.O.: 3

HT-236I
Pinza crimpatrice adatta per cavi
rg6, rg58, rg59, rg174,
confezione in blister

Art. 495136635
€ 51,46 M.O.: 2

Pinza crimpatrice in metallo
adatta per connettori telefonici 8/8

Art. 495136609
€ 18,81 M.O.: 3

Spelafili automatico
per cavi 0,2-6mm²

Art. 495136639
€ 6,21 M.O.: 7

UTENSILERIA



NOVITA' PRODOTTO

MK720
Pinza crimpatrice 2 in 1 con tester incorporato per 6P e 8P RJ11

Art. 495138598
€ 43,84 M.O.: 1

MK350
Spellacavi tronchesina a rotazione



Art. 495138593
€ 12,17 M.O.: 1

MK580
Pinza crimpatrice con tecnologia passante 8P/RJ45



Art. 495138594
€ 38,60 M.O.: 1

MK450
Pinza crimpatrice compatta con tecnologia passante 8P/RJ45



Art. 495138595
€ 24,04 M.O.: 1



MK450 Kit
Valigetta con: pinza crimpatrice (495138595) + tre barattoli di connettori a tecnologia passante (486105026 - 486105025 - 486105028)

Art. 495138596
€ 41,56 M.O.: 1



RJ45 Kit Case
Kit valigetta accessori RJ45: Spina RJ45 passante (Cat5e UTP/FTP: 60+30pz, Cat6 UTP/FTP: 60+30pz); Presa Keystone RJ45 da pannello (Cat5e/6 UTP: 10+10pz); Accoppiatore RJ45 (Cat5e UTP/FTP: 10+10pz, Cat6 UTP/FTP: 10+10pz)

Art. 486105046
€ 195,94 M.O.: 1



MK450 KitMini
Astuccio pinza crimpatrice passante con cable tester e spellacavi + connettori passanti

Art. 495138597
€ 41,56 M.O.: 1

CAVI RTX

CAVO COASSIALE impedenza 50 Ohm, conduttore CU



ARTICOLO	MODELLO	CARATTERISTICHE	CONFEZIONE	M.O.	PREZZO €
492328137	RG58CU	norme mil schermato	bobina 100mt	100	1,60

tasker

CAVI MICROFONICI

Cavo microfonico schermato bilanciato nero in matassa da 100mt



ARTICOLO	MODELLO	CONDUTTORE	M.O.	PREZZO €
492328814	114 2x025	CU	100	1,64
492328828	C128 2x035	CU + CCS	100	2,24

tasker

PIATTINE SCHERMATE



Piattine schermate adatte per diffusione sonora con conduttori in rame in matassa da 100mt

ARTICOLO	MODELLO	SEZ. NOM. (MM ²)	M.O.	PREZZO €
492328818	Tasker C118	2 X 0,14	200	1,34

tasker

PIATTINE IN CCA PER CASSE ACUSTICHE

Piattina rosso / nera bobina 100mt



ARTICOLO	SEZ. NOM (MM ²)	M.O.	PREZZO €
492328568	2 X 0.35	200	0,220
492328569	2 X 0.50	200	0,310
492328572	2 X 1.50	100	0,630
492328570	2 X 0.75	100	0,350
492328571	2 X 1.00	100	0,480



Piattina trasparente in bobina da 100mt

ARTICOLO	SEZ. NOM (MM ²)	M.O.	PREZZO €
492328574	2 X 0.35	200	0,250
492328575	2 X 0.50	100	0,280
492328576	2 X 0.75	100	0,400
492328577	2 X 1.00	100	0,470
492328578	2 X 1.50	100	0,660



GAMING



PL3200
Set tastiera e mouse gaming

Illuminazione dei caratteri e retroilluminazione, registra fino a 19 sequenze di tasti simultanee, 12 tasti multimediali, sensore ad alta precisione con quattro livelli DPI preimpostati: 1000-1600-2400-3600

Art. 486622618
€ 32,00 M.O.: 1



EW1260
Supporto di raffreddamento multiangolo

Sei ventole, due ventole da 100 mm e quattro ventole da 70mm ad alta velocità, eccellenti prestazioni di raffreddamento; adatto a notebook con schermo inferiori a 17", 2 USB 2.0, luci LED RGB - Modalità operativa 7 luci LED

Art. 486622637
€ 41,43 M.O.: 1



EW1268
Supporto per monitor pieghevole RGB

Adatto a monitor fino a 27" e fino ad un peso di 20 Kg pieghevole, illuminazione RGB, con cassetto, supporto Smartphone e 4 porte USB 3.2 Gen1

Art. 486622648
€ 43,83 M.O.: 1



ADATTATORI E CAVI USB



EW-1116
Convertitore (cavo adattatore) da USB a seriale

Art. 486621412
€ 22,62 M.O.: 2



EW9864
Convertitore da hdmi a vga con audio

Art. 486622341
€ 14,01 M.O.: 1



EW3430
Scanner laser senza fili per codici a barre

Art. 486622608
€ 63,83 M.O.: 1

MOUSE E TASTIERE

EW3108

Tastiera ps/2 e USB multimediale



Art. 486621480

€ 12,82 M.O.: 2

EW3160

Tastiera Bluetooth compatta iOS/Android/Win - IT Layout colore argento



Art. 486622602

€ 31,68 M.O.: 1

EW3255

Tastiera e mouse Bundle wireless, tasti concavi Layout IT



Art. 486622373

€ 31,42 M.O.: 1



CUFFIE E AURICOLARI

EW3563

Cuffia stereo per PC con microfono e regolazione volume



Art. 486621458

€ 9,95 M.O.: 2

EW3568

Cuffia USB Chat con microfono e controllo del volume cavo 2.1m



Art. 486622611

€ 19,88 M.O.: 1

EW3562

Cuffia stereo per PC con microfono e regolazione volume



Art. 486621877

€ 17,40 M.O.: 1

ALIMENTATORI SW

FHUB17692

USB type C adapter 13 in 1 compatibile con Mac Book, Notebook, tablet



Art. 491930100

€ 142,31 M.O.: 1

FHUB17693

USB type C adapter 5 in 1 compatibile con Mac Book, Notebook, tablet



Art. 491930101

€ 51,25 M.O.: 1

FAU17563

Caricabatterie USB C 65W nero, adatto per ogni notebook dotato di porta USB C



Art. 491929456

€ 68,88 M.O.: 1

TECNOWARE
ITALIAN POWER SYSTEMS





Etichettatrice Rhino 6000 + Kitcase

Ricca di funzioni che fanno risparmiare tempo Rhino™ 6000+ è ideale per applicazioni esigenti e di alto livello. È possibile utilizzare l'etichettatrice da sola oppure installare il software* per PC Dymo ID™ per creare e scaricare etichette. Rhino 6000+ soddisfa i principali standard di etichettatura del settore ANSI e TIA/EIA-606-B. I suoi "tasti di scelta rapida" proprietari one-touch, formattano automaticamente il testo dell'etichetta per pannelli elettrici e patch, blocchi terminali e 110, flag per fili e cavi, orditi orizzontali e verticali, applicazioni verticali e a lunghezza fissa.

MPN. 2122966

Art. 470005011
€ 853,10 M.O.: 1



Etichettatrice Dymo LM160 + 3 nastri D1 da 12mm

Etichettatrice Dymo LabelManager 160 LMR-160 in bundle con 3 nastri D1 da 12mm
CARATTERISTICHE Etichettatrice:
 - Facile digitazione del testo grazie alla tastiera QWERTY
 - Formattazione rapida con tasti intelligenti one-touch per dimensione testo, grassetto, corsivo, sottolineatura e testo verticale
 - Funziona con 6 batterie alcaline AAA (non incluse) o con l'alimentatore AC opzionale
 - Dimensioni: 203 x 118 x 49 mm
 - Peso: 350 gr

Art. 470004498
€ 224,98 M.O.: 1

Etichettatrice Rhino 4200

- Tastiera QWERTY stile computer per una facile e rapida immissione del testo
- Tasti di scelta rapida per creare e formattare etichette per avvolgimenti di fili/cavi, etichette a bandiera, codici a barre 39 e 128
- Stampa di etichette per uso industriale di 6, 9, 12 e 19mm in una vasta gamma di colori e materiali – OLTRE alla stampa diretta su tubi termoretraibili
- Funziona con 6 batterie AA (non incluse) compatibile anche con batteria agli ioni di litio a rapida ricarica

MPN. Etichettatrice S0955990 | MPN. Kit 1852996

Etichettatrice Rhino 4200

Art. 470004100
€ 232,48 M.O.: 1

Rhino 4200 Kit Case

Art. 470004465
€ 339,35 M.O.: 1



Rhino 5200 Kit Case

Etichettatrice industriale versione KIT. Robusta, versatile e dotata di imbattibili funzioni, che consentono di risparmiare tempo, la Rhino 5200 soddisfa tutti i requisiti di etichettatura ANSI e TIA/EIA-606-A. Gli esclusivi tasti di scelta rapida consentono di ottenere risultati ottimali senza spreco di tempo. Basta selezionarne uno per dimensionare, distanziare e formattare automaticamente il testo delle etichette per pannelli di connessione, cavi, fili o targhe!

MPN. S0841400

Art. 470004467
€ 605,60 M.O.: 1



Etichettatrice da scrivania LabelManager LMR-210D

Etichettatrice da scrivania
 - Navigazione semplice dall'avvio alla stampa
 - Tasti di accesso rapido per simboli e segni diacritici (ad esempio é, à, ç,...)
 - 6 dimensioni di carattere, 7 stili, 8 tipi di bordo per personalizzare l'etichetta
 - Spegnimento automatico per prolungare la durata delle batterie

MPN. S0784430



Art. 470004378
€ 119,98 M.O.: 1

LabelManager 160 LMR-160

- Facile digitazione del testo grazie alla tastiera QWERTY
- Formattazione rapida con tasti intelligenti one-touch per dimensione testo, grassetto, corsivo, sottolineatura e testo verticale
- Funziona con 6 batterie alcaline AAA (non incluse) o con l'alimentatore AC opzionale
- Dimensioni: 203 x 118 x 49 mm
- Peso: 350 gr

MPN. Etichettatrice S0946310

Art. 470004479

€ 73,73 M.O.: 1



Letratag LT 100H

Etichettatrice portatile Consumer

MPN. S0883990

Art. 470004492

€ 75,92 M.O.: 1



Nastro DYMO LT

Nastro per etichettatrici elettroniche serie LETRATAG

CODICE	MPN	TIPO	DIMENSIONE	M.O.	PREZZO €
470004439	S0721510	carta bianco	12 mm x 4 m	1	12,67
470004441	S0721620	plastica giallo	12 mm x 4 m	1	13,83

Nastri DYMO D1



CODICE	MPN	COLORE	DIMENSIONE	M.O.	PREZZO €
470004389	1978367	Nero Arancio	12 mm x 3 m	1	20,54
470004400	S0720680	Nero Bianco	9 mm x 7 m	1	30,17
470004410	S0720970	Nero Bianco	12 mm x 7 m	1	32,21
470004418	S0720610	Bianco Nero	12 mm x 7 m	1	32,21
470004420	S0720830	Nero Bianco	19 mm x 7 m	1	41,10
470004415	S0720580	Nero Giallo	12 mm x 7 m	1	32,21



Etichette RHINO nero su bianco

CODICE	MPN	TIPO	DIMENSIONE	M.O.	PREZZO €
470004140	18444	vinile	12 mm	1	36,00
470004145	18445	vinile	19 mm	1	40,81

Nastro a rilievo 3D per etichettatrici a rilievo serie consumer OMEGA

In confezione blister da 3 pezzi



CODICE	MPN	COLORE	M.O.	PREZZO €
470004451	S0847730	Nero	1	10,63
470004453	S0847750	Blu / Nero / Rosso	1	10,63

Etichette in rotolo DYMO LW

1/2 rotoli di colore bianco



CODICE	MPN	TIPO	DIMENSIONE	Q.TÀ	M.O.	PREZZO €
470004334	S0722550	multiuso	19 x 51 mm	150	1	24,33
470004338	S0722370	standard	28 x 89 mm	130	1	25,94
470004342	S0722400	esteso	36 x 89 mm	260	1	51,02



KIT PORTA UTENSILI

Valigia Trolley porta attrezzi
contiene 320 pz

Art. 812360854
€ 136,16 M.O.: 1



Valigetta porta attrezzi
contiene 105 pz

Art. 812360857
€ 42,65 M.O.: 1

Kit di utensili manuali da 45 pezzi in valigetta
Adatto per piccoli lavori domestici e manutenzioni
Dimensioni: 310 x 230 x 70 mm

Art. 495110655
€ 27,71 M.O.: 1



Valigia per tecnici in alluminio
456x330x152mm
Art. 495036024
€ 57,26 M.O.: 1



Valigia per tecnici in alluminio blu

ARTICOLO	DIMENSIONI	M.O.	PREZZO €
495036028	315 x 220 x 150mm	1	47,27
495036029	425 x 300 x 120mm	1	61,86

UTENSILERIA KNIPEX



Set di 4 pinze per seeger
Assortimento di 4 pinze per anelli di sicurezza interni ed esterni

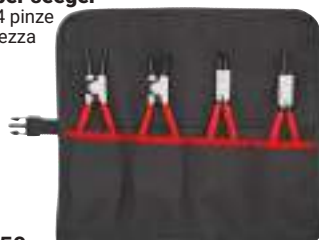

Art. 811470350
€ 89,29 M.O.: 1

Forbici da elettricista
rivestite in materiale bicomponente, rinforzate in fibra di vetro 155 mm (confezione self-service/blister)



Art. 811470140
€ 37,40 M.O.: 1

Pinza regolabile
di nuova generazione per tubi e dadi rivestiti in materiale bicomponente bonderizzata grigia 180 mm



Art. 811465155
€ 34,91 M.O.: 1

Pinza regolabile
di nuova generazione per tubi e dadi rivestiti in materiale bicomponente bonderizzata grigia 180 mm



Art. 811465155
€ 54,17 M.O.: 1

Pinza regolabile
di nuova generazione per tubi e dadi rivestiti in resina sintetica antiscivolo bonderizzata grigia



ARTICOLO	DIMENSIONE	M.O.	PREZZO €	ARTICOLO	DIMENSIONE	M.O.	PREZZO €
812285705	125 mm	1	45,31	812285715	180 mm	1	48,75
812285710	150 mm	1	46,40	812285720	250 mm	1	51,69

Trousse 100457 2pcs in similpelle per elettricisti



Art. 495110919
€ 14,25 M.O.: 1

Trousse similpelle da 4 pcs per elettricista

ARTICOLO	CARATTERISTICHE	M.O.	€
495110920	forbice, pinza, 2 cacciaviti	1	32,23
495110931	con cacciaviti 1000V VDE	1	39,71



Cacciavite cercafase a lama fissa 220-250V

ARTICOLO	CARATTERISTICHE	M.O.	PREZZO €
495110878	0.5x3x65mm 140mm	1	1,66
495110879	0.8x4x100mm 190mm	1	2,19

Cacciavite cercafase a lama fissa isolato 1000V

ARTICOLO	CARATTERISTICHE	M.O.	PREZZO €
495110880	lama 140mm VDE 0680	1	2,94
495110881	lama 190mm VDE 0681	1	3,44

Cutter con lama 100x18mm e blocco automatico

Art. 495110887
€ 4,79 M.O.: 1



Cutter pieghevole, manico bicomponente antiscivolo con lama 60x19mm

Art. 495110914
€ 14,83 M.O.: 1



Flessometro magnetico custodia in abs-gomma

ARTICOLO	CARATTERISTICHE	M.O.	PREZZO €
495110917	5mt x 25mm	1	10,50
495110916	3mt x 16mm	1	6,73



Pinza universale 160mm uni 9894 din-iso 5746

Art. 495110904
€ 17,65 M.O.: 1



Tronchese a taglio laterale in acciaio speciale per filo ad alta resistenza 1000v vde - 160 mm

Art. 495110903
€ 38,44 M.O.: 1



Pinza universale isolata in acciaio speciale 1000v vde - 180 mm

Art. 495110900
€ 42,19 M.O.: 1



Pinza a becchi lunghi mezzitondi diritti isolata 1000v vde - 160 mm

Art. 495110901
€ 38,16 M.O.: 1



Forbici 230833 doppia presa x elettricista con tagliacavo

Art. 495110885
€ 28,71 M.O.: 1



Forbici 230834 doppia presa x elettricista

Art. 495110886
€ 25,02 M.O.: 1



Forbici top quality lame dritte in acciaio 145mm per elettricisti

Art. 495110895
€ 28,27 M.O.: 1



Forbici lame dritte in acciaio 145mm per elettricisti

Art. 495110890
€ 7,69 M.O.: 1



Espositore 238035 24 pcs forbici a lama dritta

Art. 495110891
€ 182,48 M.O.: 1



Espositore 62000E 24 barattoli tasselli 6mm con viti

Art. 492515097
€ 232,75 M.O.: 1



Tasselli 6mm con viti in barattolo 100pz



Art. 492515095
€ 9,58 M.O.: 1



NASTRI ADESIVI SYROM



MASKING615 8645
Nastro adesivo in carta 25x50

Art. 494590031

€ 2,76 M.O.: 16



MISTER FIX 8638
Nastro biadesivo extra
19x1,5

Art. 494590058

€ 15,47 M.O.: 6



AMERICANO RODEO
Nastro americano multiuso

ARTICOLO	MODELLO	TIPO	M.O.	PREZZO €
494590039	4381	GRIGIO 50 x 25	6	9,38
494590040	4382	NERO 50 x 25	6	9,48
494590041	8434	GRIGIO 50 x 50	6	17,83
494590042	8433	NERO 50 x 50	6	17,83



SYLENE L/NOISE
Nastro adesivo
per imballaggio

Elevata resistenza
e capacità adesiva
Supporto: PLP
Adesivo: Acrilico 28 my
Svolgimento: silenzioso
Conf.: panetto da 6 rotoli
Dimensioni: 50mm x 66mt



ELECTRICAL290
Nastro isolante nero

ARTICOLO	MODELLO	COLORE	M.O.	PREZZO €
494590035	9899	avana	12	3,17
494590036	9900	ghiaccio	12	3,54

ARTICOLO	MODELLO	DIMENSIONI	M.O.	PREZZO €
494590043	4785	15 x 10 mt	50	0,93
494590052	4787	19 x 25 mt	16	2,78

NASTRI ADESIVI MKC



**Nastro isolante
autoestinguento**

Norma EN 60454-3-1
Materiale PVC plastificato
Resistenza 600V/ 80°C



**Nastro isolante
autoagglomerante**



Resistente all'acqua
Utilizzabile su cavi in
immersione
Isolamento adatto ad alti
voltage di cavi e fili
Forma un omogeneo
rivestimento
Adatto a riparazioni
temporanee e permanenti

ARTICOLO	COLORE	LUNGHEZZA	DIMENSIONE	M.O.	PREZZO €
492518120	nero	10 metri	0,13 x 15 mm	20	0,48
492518121	bianco			20	0,66
492518122	rosso			20	0,63
492518123	blu			20	0,63
492518124	giallo / verde			50	0,74
492518155	marrone			20	0,63
492518156	grigio			20	0,63
492518126	nero	25 metri	0,13 x 19 mm	20	1,40
492518128	rosso			10	1,47
492518132	nero			20	1,20
492518133	bianco			20	1,42
492518134	rosso			20	2,01
492518135	blu			20	2,01
492518138	nero		0,13 x 25 mm	10	1,66
492518139	bianco			20	2,23
492518140	rosso			10	2,63
492518142	giallo / verde			10	2,84
492518144	nero			10	4,81
492518145	bianco		10	4,64	

ARTICOLO	DIMENSIONI	M.O.	PREZZO €
492518153	0,75x19mm x 5mt	10	4,70
492518154	0,75x19mm x 10mt	10	6,87
492518165	0,75x25mm x 10mt	10	9,80

Adattatore di alimentazione
Spina DC 5,5 x 2,1 mm
morsetti a vite TV-01



Art. 433330132
€ 0,66 M.O.: 50

Adattatore di alimentazione
Spina USA/Italia 10A



Art. 433329872
€ 2,07 M.O.: 20

Adattatore AV
Adattatore spina DVI
dual link e presa HDMI



Art. 433330138
€ 11,62 M.O.: 5

Adattatore AV
Adattatore video
90° spina/presa HDMI



Art. 433330122
€ 4,97 M.O.: 10

Adattatore AV
Adattatore SCART - RCA - IN/OUT



Art. 433330029
€ 1,63 M.O.: 10

Adattatore audio
Cavetto adattatore spina 2 prese
stereo 3,5 mm



Art. 433330085
€ 3,17 M.O.: 10

Adattatore audio
Spina mono 6,3 mm
presa tipo cannon
3 poli



Art. 433329757
€ 3,63 M.O.: 10

Adattatore audio
Spina mono 6,3 mm
presa tipo cannon
3 poli (metallico)



Art. 433329756
€ 3,97 M.O.: 10

Adattatore audio
Spina stereo 3,5 mm / 2
Prese stereo 3,6mm



Art. 433329580
€ 1,59 M.O.: 20

Adattatore
bnc maschio - f
femmina



Art. 433329491
€ 1,18 M.O.: 20

**Adattatore f
maschio**
Spina F / Presa
9,5mm TV



Art. 433329747
€ 1,15 M.O.: 20

**Adattatore
coassiale**
Spina TV - spina
TV ø 9,5mm



Art. 433329588
€ 0,36 M.O.: 20

**Adattatore
coassiale**
Presa TV - presa
TV ø 9,5mm



Art. 433329626
€ 0,47 M.O.: 10

**Adattatore
coassiale**
Sdoppiatore d' antenna
1 presa 2 spine coassiali 9,5 mm



Art. 491214552
€ 0,86 M.O.: 50

**Adattatore
coassiale**
Sdoppiatore d' antenna
1 spina 2 prese coassiali 9,5 mm



Art. 491214551
€ 0,79 M.O.: 20

Presse alimentazione DC
Volante 9/5,5x2,1mm



Art. 433329688
€ 0,310 M.O.: 100

Presse RCA
Da pannello dorata



ARTICOLO	COLORE	M.O.	€
433329569	rossa	10	3,81
433329570	nera	10	3,65

Presse audio
Presse microfonica volante
schermata 5 poli



Art. 492515935
€ 1,24 M.O.: 10

**Presse bnc
da pannello**
impedenza 50 ohm



Art. 492515804
€ 0,92 M.O.: 20

Presse coassiale
9,5mm bianca alta qualità



Art. 491218697
€ 0,413 M.O.: 100

Presse coassiale
Schermata 90° 9,5 mm
alta qualità



Art. 491218678
€ 1,90 M.O.: 50

Giunto per cavo tv
fissaggio cavo a vite



Art. 491214350
€ 0,494 M.O.: 20

**Barrette di terminali diritti
sezionabili**
40 pin passo 2,54 mm



Art. 492517596
€ 1,22 M.O.: 20

Connettore serie d
dritto 9 poli femmina per c.s.



Art. 492515335
€ 0,89 M.O.: 50



MINUTERIA: SPINE

Spina audio xlr 3 poli nera



Art. 492518609

€ 4,35 M.O.: 10

Spina audio di alimentazione Jack 6,3 mono NE



Art. 492518600

€ 1,74 M.O.: 10

Spina bnc a crimpare Per microcoax tvcc



Art. 492515780

€ 2,70 M.O.: 40

Spina rca volante con guidacavo



ARTICOLO	CARATTERISTICHE	M.O.	PREZZO €
433329864	CT2005 PLUG WHITE	200	0,190
433329865	CT2005 PLUG BLACK	200	0,190
433329866	CT2005 PLUG RED	200	0,190
433329867	CT2005 PLUG YELLOW	200	0,179

Spina coassiale 9,5 mm volante



Art. 491218665

€ 0,402 M.O.: 100

Spina coassiale 9,5mm bianca alta qualità



Art. 491218695

€ 0,389 M.O.: 100

Spina coassiale 9,5 mm volante schermata 90° alta qualità



Art. 491218677

€ 1,350 M.O.: 50

Spina coassiale 9,5 mm volante 90°



Art. 491214814

€ 0,515 M.O.: 100

Spina sma dorata 90° a crimpare per rg-58 e rg-174



Art. 433330266

€ 5,61 M.O.: 10

Spina n a crimpare per rg-58 isolamento in polipropilene



Art. 492515777

€ 5,90 M.O.: 10

Spina f volante Per RG-58 (versione economica)



Art. 492515723

€ 0,284 M.O.: 200

Spina f volante Per RG-6 (versione economica)



Art. 492515725

€ 0,179 M.O.: 200

MINUTERIA

Fissacavo Tondo conf. 100pz



ARTICOLO	DIAMETRO	M.O.	PREZZO €
491214410	5,0 mm	10	1,24
491214411	6,0 mm	10	1,38
491214412	7,0 mm	10	1,49
491214413	8,0 mm	10	1,49
491214414	9,0 mm	10	1,72
491214415	10,0 mm	10	1,82

Fissacavo Piatto conf. 100pz



ARTICOLO	DIAMETRO	M.O.	PREZZO €
491214416	5,0 mm	10	1,18
491214417	6,0 mm	10	1,24
491214418	7,0 mm	10	1,31
491214419	8,0 mm	10	1,43

Elemento di fissaggio per conchiglia vite lunga

Art. 492515713

€ 0,763 M.O.: 100



Elemento di fissaggio per conchiglia vite corta

Art. 492515714

€ 0,438 M.O.: 100





**WXS smart
POWER UNIT 230V F/G**

Risponde a tutte le esigenze applicative di picosaldatura, microsaldatura, saldatura heavy duty e pinzette per saldatura. A WXS smart è possibile connettere fino a 16 utensili. Non occorrono stazioni aggiuntive.

Art. 495238915
€ 2.264,15 M.O.: 1



**T0053298699
Stazione saldante
Professional WE 1010**

- Saldatore WEP70 (70 W, 24 V) range di temperatura 50-450° C
- Stazione ESD per applicazioni professionali
- Nuovo supporto PH7 ridisegnato che offre un sostegno sicuro dello stilo

Art. 810340380
€ 358,94 M.O.: 1



**T0053439699N
Unità di controllo digitale
1 canale, 150 W**

Il sistema di saldatura WT1011H è composto dalla unità di alimentazione WT1H da 150W e dallo stilo saldante WP200 da 200W corredato dal supporto di sicurezza WSR201

Art. 810345255
€ 1.210,94 M.O.: 1



**T0052920999N
Saldatore WXP 80 80 W, 24 V**

Con tecnologia di riscaldamento Silver-Line. Questo kit è costituito dal saldatore 80W che offre un eccellente controllo e si collega ai sistemi di saldatura e dal supporto di sicurezza per l'uso con tutti i saldatori WX.

Art. 810345170
€ 560,15 M.O.: 1

**T0056104699
Saldatore a basso voltaggio
magnastat, 100W 230V**

Completo di punta saldante ct6e7 e appoggio di sicurezza. Famiglia punte ct6 (lt, pt) Range della temperatura 370° C

Art. 810930825
€ 224,79 M.O.: 1



**T0051512699N
Set di pulizia per stazione
saldante e punte**

Pulitore WDC, barretta rimozione ossidazioni WPB1 e Tip Activator

Art. 810340790
€ 110,58 M.O.: 1

Punte Weller

	ARTICOLO	MPN	TIPO	ADATTA PER	M.O.	PREZZO €
1	810445780	LHT C	a cacciavite 3,2 x 1,2 mm	LR21 ET-SMD	1	25,02
2	810960455	T0054445199	a scalpello 6,7 x 1,8 mm	WSP 150	1	25,02
3	810640385	4ETB-1	a cacciavite 2,4 x 08 mm	stilo temtronic Ir21	1	11,42
4	810915655	4ETC-1	a cacciavite 3,2 mm	stilo temtronic Ir21	1	11,42



**T0051612499
Punta ad ago extra sottile
0,5 mm, per Pyropen Piezo**

Art. 810970465
€ 27,19 M.O.: 1



Filo per saldatura

ARTICOLO	MPN	DIAMETRO	PUNTO FUSIONE	PESO	M.O.	PREZZO €
810405345	T0051388599	0,8 mm	221° C	250 gr	1	121,46
810375710	T0051386299	1 mm	221° C	500 gr	1	223,54
810405340	T0051387699	0,5 mm	227° C	500 gr	1	143,21



WELLER FILTRATION

**T0053657199N
Kit di aspirazione fumi**

Braccio di aspirazione Easy-Click 60

IMBUTO
- larghezza: 230 mm
- altezza: 100 mm

BRACCIO FLESSIBILE
- lunghezza: 1 m
- diametro: 60 mm
- con valvola a farfalla

Art. 810335945
€ 498,52 M.O.: 1



**T0053641099
Filtro estrattore fumi di saldatura, serie WFE 2P**

Filtro compatto per WFE, WFE P, WFE 2P, FT 12, FT 11, FE 4000



Art. 810335950
€ 150,46 M.O.: 1



WELLER CONSUMER



**WLBUK75
Saldatrice a gas butano 25/75 W**

Kit saldatore cordless 25/75W ad aria calda. Alimentato a butano (non incluso). Lo strumento perfetto per ogni esigenza di saldatura!

Art. 812350415
€ 171,23 M.O.: 1

**T0051383199
Flussante colofonico attivato senza alogeni 100 ml**



Art. 810510415
€ 38,98 M.O.: 1

best seller

**WLACCHHM-02
Supporto terza mano Weller con 4 bracci magnetici mobili**

4 bracci a collo d'oca magnetici con morsetto a coccodrillo fissato alla base facilmente posizionabile per configurazioni multiple



Art. 812270605
€ 71,35 M.O.: 1

WELLER EREM

**3SASL
Pinzette di precisione**

Per applicazioni in microelettronica, gioielleria, orologeria, medicina e tecnica di laboratorio

Art. 810335835
€ 23,56 M.O.: 1



**4SASL
Pinzette**

A becco diritto / appuntito / sollevato lunghezza 110 mm, anti-magnetica in acciaio inox

Art. 810335840
€ 20,29 M.O.: 1



MKC-6C
Pistola termocollante
25W

Art. 495136655
€ 12,40 M.O.: 1



Art. 545700306
€ 48,60 M.O.: 1

MKC-508
Pistola ad aria calda 1500W
Alimentazione: 220/240Vca



MKC-708
Saldatore stilo con controllo
temperatura 30-50W

Art. 495236125
€ 21,57 M.O.: 1



MK-728/25W
Saldatore stilo a filo da 25W

Art. 495236504
€ 11,47 M.O.: 1



MK-728/40W
Saldatore stilo a filo da 40W

Art. 495236505
€ 11,62 M.O.: 1



MK-728/60W
Saldatore stilo a filo da 60W

Art. 495236506
€ 12,27 M.O.: 1



MK-728/100W
Saldatore stilo a filo da 100W

Art. 495236507
€ 15,38 M.O.: 1



MKC-507
Saldatore istantaneo
a pistola 100W

Art. 495236122
€ 25,08 M.O.: 1



MK-729/130W
Saldatore a pistola da 130W
doppia potenza

Art. 495236508
€ 13,51 M.O.: 1



MK-751
Saldatore stilo a filo
con potenza regolabile
da 100W

Art. 495236509
€ 28,07 M.O.: 1



MK-006A/12W
Kit Saldatore stilo
portatile wireless
ricaricabile USB-C

Art. 495236511
€ 32,21 M.O.: 1



WS200N
Saldatore stilo a filo
con impugnatura antiscivolo
da 40W, schuko

Art. 495236501
€ 12,74 M.O.: 1



WS-70DA
Saldatore stilo a filo
con potenza
selezionabile
20/130 W

Art. 495236157
€ 13,11 M.O.: 1



LABORATORIO E SALDATURA

Saldatore stilo di ricambio
per MKC WS-937 e WS-931
da 50W



Art. 495236153
€ 19,63 M.O.: 1

Saldatore stilo di ricambio
per MKC-927 da 12V 8W



Art. 495236178
€ 5,30 M.O.: 1

ZD-20D
Saldatore portatile a batteria
3 batterie AA da 1,5V



Art. 495236176
€ 15,53 M.O.: 1

MKC-20U
Saldatore a stilo 8W 5Vdc
con connessione
USB

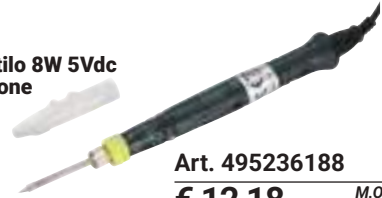

Art. 495236188
€ 12,18 M.O.: 1



Pistola Dissaldante di ricambio 7pin
per MKC DM-917 / DM-915

Art. 495236148
€ 57,14 M.O.: 1

WS-211
Dissaldatore a stilo 40W



Art. 495236171
€ 11,41 M.O.: 1



MKC-8916
Stazione saldante 60W
LEAD-FREE con LCD

Art. 495236260
€ 176,77 M.O.: 1



MKC-8915
Stazione dissaldante 90W
LEAD-FREE con LCD

Art. 495236261
€ 203,26 M.O.: 1



WS98
Stazione saldante
48W - 150/450°C

Art. 495236162
€ 32,34 M.O.: 1



WS919
Stazione saldante
50W - 150/450°C

Art. 495236165
€ 90,34 M.O.: 1



WS931
Stazione saldante
50W - 150/450°C
con Digit display
e regolazione della temperatura

Art. 495236166
€ 108,81 M.O.: 1



WS937
Stazione saldante
50W - 150/450°C
con Digit display
regolazione della temperatura
e tasti multifunzione

Art. 495236164
€ 118,58 M.O.: 1

LABORATORIO E SALDATURA



MKC-8908
Stazione di rilavorazione
e dissaldatura ad aria calda SMD

Art. 495236315
€ 135,83 M.O.: 1



DM-915
Stazione dissaldante da 80W
con range 60-480°C

Art. 495236251
€ 213,43 M.O.: 1

DM-917
Stazione multifunzione:
saldatura e dissaldatura
per applicazioni
Lead Free



Art. 495236253
€ 355,71 M.O.: 1



MKC-927
Mini Stazione Saldante
da 8W 230V con controllo
della temperatura 100/450°C

Art. 495236177
€ 25,65 M.O.: 1



WS920A
Kit di saldatura
5 pezzi

Art. 495236180
€ 22,52 M.O.: 1



WS303
Kit di saldatura

Art. 495236183
€ 23,05 M.O.: 1

MKC-1937-2
Saldatore torcia 2in1
professionale a gas



Art. 495236038
€ 38,58 M.O.: 1

MKC-10G
Supporto snodabile
per saldatura
con lente e porta
saldatore



Art. 495237832
€ 12,01 M.O.: 1

ZD-11M-1
Supporto terza mano
per saldatura

Composto da 4 bracci
regolabili, porta rocchetto
stagno, spugna, lana di
metallo e fluxante



Art. 495237833
€ 18,47 M.O.: 1

MK-8988
Stazione saldante
digitale con bracci
di supporto

Controllo preciso
della temperatura,
con un range da 160°C
a 480°C regolabile
con incrementi di 1°



Art. 495236510
€ 55,17 M.O.: 1

WS-193
Pompa aspira
stagno
in metallo



Art. 495236169
€ 4,95 M.O.: 1

3 punte di ricambio
Per saldatore: MK-006A/12w
Il sacchetto contiene una punta conica,
una a taglio e una a cacciavite

Art. 495236512
€ 15,59 M.O.: 1



LABORATORIO E SALDATURA

10 punte di ricambio

Per saldatore: WS-929A / WS-937 / WS-931 / WS-70DA - forma conica



Art. 495236190

€ 23,63 M.O.: 1

10 punte di ricambio

Per saldatore: WS-929A / WS-937 / WS-931 / WS-70DA - 0/5mm ad ago



Art. 495236191

€ 23,63 M.O.: 1

10 punte di ricambio

Per saldatore: WS929A / WS937 / WS931 / WS70DA - 0/2mm a cacciavite



Art. 495236193

€ 23,63 M.O.: 1

10 punte di ricambio

Per saldatore: WS-98 MKC (B1-1) 1,5mm - forma conica



Art. 495236220

€ 20,21 M.O.: 1

Kit punte di ricambio MKC

Lead-Free per DM-912 / DM-916 / DM-917 - 3 pezzi



Art. 495236212

€ 8,26 M.O.: 1

10 punte di ricambio

Per saldatore: per MKC-418 (N9-1) 0,5mm - forma conica



Art. 495236270

€ 27,76 M.O.: 1

Kit ugelli

Per dissaldatore DM-915 e DM-917 - 3 pezzi



Art. 495236213

€ 8,10 M.O.: 1

STAGNO

Treccia dissaldante

ARTICOLO	Ø FILO (MM)	M.O.	PREZZO €
495237823	2,0	5	1,88
495237824	2,5	5	1,95
495237825	3,0	5	2,08



Pasta saldante 30gr

in confezione di plastica



Art. 495237836

€ 1,88 M.O.: 5

Grasso al silicone in tubetto

ARTICOLO	MODELLO	GR	M.O.	PREZZO €
495338147	WP205	5	10	2,17
495338148	WP235	35	2	8,73



Stagno in tubetto 60/40

ARTICOLO	TIPO	M.O.	PREZZO €
495237915	1,0mm 15gr	1	3,53
495237916	1,5mm 15gr	1	3,64
495237917	1,5mm 30gr	1	3,93



ZD-160

Stagno in tubetto

Lead Free sn/cu
1.0mm 10gr



Art. 495237829

€ 2,66 M.O.: 1

Stagno in rocchetto

LEAD FREE 99/1
1,0mm 500gr



Art. 495237921

€ 81,44 M.O.: 1

Stagno in rocchetto 60/40



ARTICOLO	Ø FILO (MM)	PESO (GR)	M.O.	PREZZO €
495237893	0,5	100	1	12,37
495237903		250	1	31,63
495237899		500	1	55,02
495237904	0,7	100	1	11,91
495237905		250	1	29,57
495237894		500	1	50,19

ARTICOLO	Ø FILO (MM)	PESO (GR)	M.O.	PREZZO €
495237891	1,0	100	1	11,36
495237901		250	1	28,70
495237895		500	1	52,49
495237897		1000	1	95,10
495237892	1,5	100	1	11,48
495237902		250	1	28,64
495237896		500	1	49,28
495237898		1000	1	96,29

STRUMENTAZIONE ICE

ICE-680/G
Multimetro analogico
professionale con
prova diodi e transistor

Art. 530134500
€ 164,65 M.O.: 1



ICE-680/R
Multimetro analogico
professionale con
buzzer di continuità

Art. 530134502
€ 161,63 M.O.: 1



Coppia di puntali di ricambio



1



2

	ARTICOLO	COMPATIBILITÀ	M.O.	PREZZO €
1	530134081	per 680/R ICE	5	20,96
2	530134082	per 680/g ICE ICE P/2	5	23,41

STRUMENTAZIONE MKC

melchioni
mkc



Analizzatore satellitare SPECTRUM MKC WS6986

H265 + 10BIT + WIFI + FIBRA OTTICA

Display LCD TFT 7 pollici
Completa compatibilità DVB-S/S2/T/T2/C, MPEG-2/MPEG-4
Decodifica hardware MPEG-2 / H.264 / H.265 10 Bit
Indicazione digitale dell'intensità e qualità del segnale
Analisi della costellazione e dello spettro
Batteria al litio 7,4 V 5 Ah

ARTICOLO	PRODOTTO	M.O.	PREZZO €
530134222	Analizzatore Satellitare Spectrum MKC 6986	1	835,46
530134223	Batteria di ricambio al litio 7,4V / 5000Mah	1	53,28

POWER EASY NEW
Misuratore di potenza
16A 230V
con display
retroilluminato

Art. 530134224
€ 21,12 M.O.: 1



MK18
Multimetro digitale
tascabile DC/AC 600V

NCV

Art. 530135307
€ 11,89 M.O.: 1



**NOVITA'
PRODOTTO**

EM-320A
Multimetro digitale
autorange

tascabile

Art. 530134336
€ 12,80 M.O.: 1



MKC-666B
Multimetro
analogico

tascabile

Art. 530135304
€ 18,10 M.O.: 3



MKC-365B
Multimetro
analogico con misura
di continuità

multifunzione

Art. 530135305
€ 33,28 M.O.: 1



STRUMENTAZIONE MKC



EM-465A
Pinza amperometrica
con temperatura
e frequenzimetro

Art. 530134364
€ 41,67 M.O.: 1



EM-305A
Pinza
amperometrica
digitale
autoranging

Art. 530134363
€ 42,66 M.O.: 1



EM-400
Pinza
amperometrica
autorange
AC/DC 600A

Art. 530134366
€ 62,04 M.O.: 1



MK305A
Pinza amperometrica
digitale con autoranging
AC/DC 600V

Art. 530135306
€ 38,60 M.O.: 1



MK28B
NCV Cercafase digitale AC
48~1000V (bassa sensibilità)
12~1000V (alta sensibilità)
Frequenza 50Hz/60Hz

Art. 530135308
€ 11,69 M.O.: 1



MK390B
Multimetro digitale
DC/AC 300V con test
batterie e diodi

Art. 530135309
€ 19,69 M.O.: 1



**NOVITA'
PRODOTTO**



Kit Elettricista

Kit professionale per misurazioni elettriche

Questo pratico kit include tutto il necessario per eseguire misurazioni elettriche precise e sicure.

Multimetro digitale (cod. 530135309):
consente di misurare tensione, corrente e resistenza con precisione.

Pinza amperometrica (cod. 530135306):
permette di misurare la corrente senza dover scollegare i cavi, utile per monitorare il flusso di corrente in modo rapido e sicuro.

Cercafase (cod. 530135308):
strumento indispensabile per verificare la presenza di tensione su impianti elettrici, garantendo maggiore sicurezza durante le operazioni.

Perfetto per elettricisti, tecnici e fai-da-te, questo kit è compatto, facile da usare e adatto sia per professionisti che per appassionati di elettronica.

Art. 530135312
€ 63,14 M.O.: 1

Sonda del cavo di prova del multimetro

ARTICOLO	CORRENTE IN USCITA	M.O.	PREZZO €
530134390	10A	1	9,56
530134391	20A	1	12,54



MKC-104A
Modulo termometro
digitale a pannello
con sonda

Art. 493933668
€ 15,16 M.O.: 1





UT161B
Multimetro Digitale
da 1000V

con TRMS

Art. 530134377
€ 130,31 M.O.: 1



UT-139A
Multimetro digitale
autorange

con TRMS - NCV
Tensione AC/DC 600V

Art. 530134349
€ 77,48 M.O.: 1



UT-139C
Multimetro digitale
autorange

con TRMS - NCV
Tensione AC/DC 600V

Art. 530134376
€ 99,50 M.O.: 1



UT133A
Multimetro digitale
da 600V

con autorange

Art. 530134375
€ 44,10 M.O.: 1



UT131D
Multimetro digitale
palmare

con sistema NCV
Tensione AC/DC 250V

Art. 530134339
€ 25,88 M.O.: 1



UT131C
Multimetro digitale
palmare

con temperatura
Tensione AC/DC 250V

Art. 530134338
€ 27,19 M.O.: 1



UT131A
Multimetro digitale
palmare AC 10A

con autorange
Tensione AC/DC 250V

Art. 530134337
€ 32,88 M.O.: 1



UT123T
Multimetro palmare
digitale

con sistema NCV
con autorange
Tensione AC/DC 600V

Art. 530134344
€ 28,23 M.O.: 1



UT-120C
Multimetro digitale
autorange

con capacità e
corrente AC/DC
Tensione AC/DC 600V

Art. 530134342
€ 40,77 M.O.: 1



UT120A
Multimetro Digitale
tascabile

con autorange

Art. 530134340
€ 32,13 M.O.: 1



UT207B
Pinza Amperometrica
da 1000A

Art. 530134374
€ 161,48 M.O.: 1



UT-213C
Pinza Amperometrica

con sistema NCV
autorange e TRMS

Art. 530134369
€ 123,92 M.O.: 1



UT-603
Misuratore di
induttanza e capacità

Art. 530134331
€ 90,10 M.O.: 1





UT-522
Misuratore di
resistenza di terra

Art. 530134326
€ 340,52 M.O.: 1



UT387E
Scanner rilevatore
digitale

Rilevazione:
- metalli
- legno
- cablaggio sotto
tensione

Art. 530134392
€ 106,08 M.O.: 1



LM100A
Distanziometro Laser

capacità 100m

Art. 530134384
€ 73,63 M.O.: 1



LM575LD
Livellatrice
Laser 3D

Art. 530134383
€ 259,17 M.O.: 1



UT693D
Misuratore potenza
Fibra Ottica

Art. 530134378
€ 88,07 M.O.: 1



UT18D
Tester di Tensione e
Continuità

Art. 530134381
€ 96,10 M.O.: 1



UT658B
USB Tester

Art. 530134379
€ 17,43 M.O.: 1



UT07B
Tester per
prese a muro

Art. 530134380
€ 19,38 M.O.: 1



UT-333
Mini rilevatore
temperatura ed umidità

Art. 530134370
€ 35,65 M.O.: 1



UT-353
Mini fonometro
Digitale da 30/130db

Art. 530134371
€ 33,29 M.O.: 1



UT-363
Mini anemometro
Digitale da 0-45m/s

Art. 530134372
€ 33,15 M.O.: 1



UT-383
Mini luxmetro
Digitale da 0-9999lux

Art. 530134373
€ 34,15 M.O.: 1



Multimetro a pinza 1000A

AC/DC RMS
diam. 40 mm

Art. 810200390
€ 870,83 M.O.: 1



F65 Multimetro a pinza 100 AC RMS, corr. dispersione

Art. 810200395
€ 1.047,92 M.O.: 1



C.A 755 Tester Digitale

Art. 810200590
€ 222,92 M.O.: 1



C.A 1631 Calibratore di Processo VoltmA

Art. 810200415
€ 1.779,17 M.O.: 1



ACCESSORI PER STRUMENTAZIONE CHAUVIN ARNOUX



KIT ACCESSORI (R/N)
Art. 810200610
€ 147,92 M.O.: 1

- 2 pinze coccodrillo - CAT. IV
- 2 puntali - CAT. IV
- 2 puntali ø 4mm - CAT. II
- 2 cavi 90°/dritto 1,5m - CAT. IV



PINZE COCCODRILLO (R/N)
Art. 810200500
€ 70,83 M.O.: 1

Pinza coccodrillo Cat4
1kV RD/BK



PUNTI DI MISURA (R/N) 15A

ARTICOLO	MPN	CARATTERISTICHE	M.O.	PREZZO €
810200510	P01295454Z	1.000V CAT. IV	1	41,67
810200515	P01295458Z	300V CAT. II	1	41,67

PUNTI DI MISURA (R/N)



Art. 810200520
€ 41,67 M.O.: 1



CAVI + PUNTI (R/N)
Spina maschio dritto ø 4mm 300V
Cat2 15A



CAVI DI SICUREZZA (R/N)

Art. 810200540
€ 72,92 M.O.: 1
Cavi di sicurezza Cat3 1000V 15A
MPN. P01295290Z

PUNTI MAGNETICI 90° (R/N)



Art. 810200545
€ 114,58 M.O.: 1
Puntali Cat3 1000V 4A
MPN. P01103058Z



ARTICOLO	MPN	DIMENSIONE	M.O.	PREZZO €
810200620	P01295474Z	2mm / L=1,5m	1	75,00
810200625	P01295475Z	4mm / L=1,5m	1	77,08



SMART PHOTO FRAME

Photo frame digitale WiFi da 10" touch, con cornice di colore bianco, display IPS 1280x800, con connessione WiFi e 1GB RAM + 16GB ROM, e speaker amplificati.

Permette di inviare foto e video (15sec) dallo smartphone al photo frame. Il photo-frame può essere posizionato sia in verticale che in orizzontale. La fotografia verrà automaticamente ruotata ed adattata senza lasciare sgradevoli bordi.

Funziona anche off-line: se non hai una connessione Internet o sei sotto firewall in ufficio, non c'è problema! Potrai sempre riprodurre le fotografie a te più care, da una memoria esterna di tipo SD (MicroSD) o USB.

Usa lo smartphone come hotspot per inviare le foto al photo-frame. Condividi gli istanti più belli con i tuoi cari ovunque nel mondo!



CARATTERISTICHE

- Risoluzione: 1280x800
- Dimensione: 28,5 x 26,5 x 2,4 cm
- Tipo di pannello: IPS
- RAM ROM: 1GB 16GB
- Connessione Wireless: 2.4Ghz
- Ruotabile Pivot Orizzontale/Verticale
- APP Frameo per iOS e Android

HD 720p
Micro SD
App Frameo



DPF-IR10B

Art. 559560730

€ 129,00 M.O.: 1

DPF-IR10W

Art. 559560731

€ 129,00 M.O.: 1

TV E DECODER



DECODER DIGITALE TERRESTRE DVB-T2 HEVC H.265 60HZ, 10BIT

Il nuovo Digitale Terrestre in Alta Definizione!

DTR-3340

CARATTERISTICHE

- Supporta standard DVBT e DVBT2 HD
- Compressione MPEG-2, MPEG-4/H.264, HEVC/H.265 10bit
- Supporto LCN (Numerazione Automatica dei Canali)
- Funzione EPG (Guida Elettronica programmi)
- Sintonia canali automatica e manuale
- Funzione Media Player integrata con riproduzione file: video: AVI/MKV/MP4 | audio: MP3 | immagini: JPG, BMP
- Supporto Sottotitoli/Audio Multilingue (ove supportato)
- Funzione televideo (teletext)
- Funzione Parental Control (Blocco Canali)

- Risoluzione Max Supportata 1080p 60Hz
- Formato Video: 16:9, 4:3cc, 4:3ff, 4:3lb
- Sintonizzazione fino a 1000 canali
- Connessioni: HDMI (1.4v)
- Telecomando unificato in dotazione, programmabile con il tv per la gestione di entrambi i dispositivi
- Software multilingua aggiornabile
- Consumo: stand by max 0.5W / Accesso max 7W
- Alimentazione DC 5V- 1A
- Dimensioni e Peso: 61x24x14mm | 58 gr

Art. 559570235

€ 47,50 M.O.: 1



DECODER DIGITALE TERRESTRE DVB-T2 HEVC H.265 60HZ, 10BIT

Il nuovo Digitale Terrestre in Alta Definizione!

Irradio DTR-3341 e Zodiac DZR-3341

DTR-3341 supporta le attuali trasmissioni conformi allo standard DVB-T2 digitale terrestre ed è compatibile con le specifiche dello "switch off 2021" secondo il nuovo standard DVB-T2 HEVC H.265 60Hz, 10bit. È possibile ricevere tutti i canali del digitale terrestre sia in bassa che in alta definizione e grazie alla porta USB player in dotazione, il decoder integra un vero e proprio Media player, per la riproduzione di foto, filmati, e musica da supporto USB o Hard disk.

CARATTERISTICHE

- Definizione: 1080P 60HZ
- Supporta standard DVBT e DVBT2 HD
- Compressione MPEG-2, MPEG-4/H.264, HEVC/H.265 10bit
- Supporto LCN (Numerazione Automatica dei Canali)
- Funzione EPG (Guida Elettronica programmi)
- Telecomando programmabile
- Risoluzione max supportata 1080p 60Hz
- Formato Video: 16:9, 4:3cc, 4:3ff, 4:3lb
- Funzione Media Player integrata con riproduzione file:
 - video formato: AVI/MKV/MP4
 - audio formato: MP3
 - immagini formato: JPG, BMP
- Funzione televideo (teletext)
- Funzione Parental Control
- Connessioni: HDMI (1.4v), SCART
- Alimentazione: 100 VAC - 240VAC ~50-60HZ / DC 12V- 1A



ARTICOLO	MODELLO	M.O.	PREZZO €
559570234	Irradio DTR-3341	1	47,50
559570238	Zodiac DZR-3341	1	41,85

VDP-IR SMART 800 4K UHD: IL CINEMA COME VUOI TU!

Trasforma ogni ambiente in una sala cinematografica con il nuovo VDP-IR Smart 800 4K UHD. Design minimale ed elegante, prestazioni da top di gamma e tutta la semplicità di Android TV 12 integrato.

Perché sceglierlo?

- **Immagini mozzafiato:** Risoluzione nativa 4K Ultra HD con HDR10 e tecnologia MEMC per una fluidità perfetta, ideale per sport e gaming.
- **Luminosità superiore:** Con 800 ANSI Lumen, goditi dettagli nitidi anche in ambienti illuminati, su schermi da 50" fino a ben 200".
- **Tutto lo streaming che ami:** Netflix, YouTube, Prime Video e DAZN sono già pronti all'uso. Scarica migliaia di altre app direttamente dal Google Play Store.
- **Installazione smart:** Dimentica i settaggi complicati. Grazie alla messa a fuoco e correzione trapezoidale automatica, lo posizioni e lui pensa a tutto il resto.

Tecnologia "Dust Free" per durare nel tempo

A differenza dei proiettori comuni, il VDP-IR 800 vanta un motore ottico sigillato. Prodotto in ambienti sterili, garantisce un'immagine sempre pulita, previene macchie nere o ingiallimenti e assicura una dissipazione del calore silenziosa ed efficiente.

Caratteristiche principali

- Sorgente luminosa: LED
- Pannello: LCD 5.5 pollici
- Durata sorgente luminosa: 40.000 ore
- Risoluzione nativa: UHD 4K 2160p / 4096 x 3840 pixels
- Luminosità: 800 ANSI / 4.000 Lumen
- Contrasto: 1.500:1
- Regolazione del fuoco: Elettronico ed automatico
- Correzione del trapezio: Elettronico ed automatico
- Motore Ottico Dust Free
- Color Gamut: 46%@NTSC CIE1931
- Distanza di proiezione: 1.1 - 4.5mt
- Dimensione immagine: 50 -200 pollici
- Multimedia:
 - HDMI: 1HDMI 2.1 + HDMI 2.1 ARC, per la connessione in HD a lettori BLU ray, DVD, Decoder, Game console
 - USB player per la visualizzazione di: Video, musica, foto, documenti
- Ingressi AV e multimedia: HDMI 2.1 x 2 / USB x 2 / AUDIO OUT x 1
- Connessione WIFI 2.4G/5G Wi-Fi: Miracast/Airplay/DLNA/Windows PC cast
- Altoparlante stereo: 2*8W
- Memoria: 2GB + 8GB
- Trasmettitore/Ricevitore Bluetooth 5.0 integrato
- Attacco per treppiede: tipo UNC1/4
- Ingresso alimentazione: 100-240V~50/60Hz
- Dimensioni prodotto (LxAxP): 270 x 260 x 135mm

Contenuto della confezione

- 1 * Proiettore UHD/4K
- 1 * Telecomando (2 x AAA non incluse)
- 1 * Manuale dell'utente
- 1 * cavo d'alimentazione

Art. 558100560

€ 1.039,58 M.O.: 1

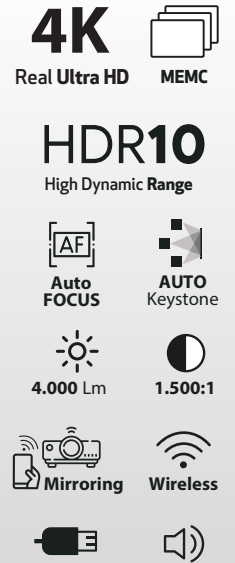

4K ULTRA HD

HDR10 High Dynamic Range

MEMC Motion Estimation Motion Compensation



VDP-IR LASER TV 650HD, LA RIVOLUZIONE SMART NELLA VIDEOPROIEZIONE

Vivi il grande schermo dove vuoi!

Videoproiettore Laser TV a ottica ultra corta con sistema Android 11, tecnologia DLP e sorgente laser RGB. Immagini brillanti in Full HD con supporto 4K e luminosità eccezionale (650 ANSI).

Audio stereo 2x5W potente e definito. Con Wi-Fi dual band, Wireless, mirroring da smartphone e messa a fuoco automatica. Dotato di 2 ingressi HDMI 2.0, USB con media player integrato, uscite audio analogica (jack 3,5mm), digitale (ottico SPDIF) e connessione Wireless OUT per speaker esterni. Ideale per film, gaming, eventi, presentazioni e soprattutto per un'esperienza Home Cinema immersiva e coinvolgente.

Caratteristiche principali

- Colore: Dark Grey
- Display: DLP
- Durata del laser: 30.000 ore
- Luminosità del proiettore: 650 ANSI / 2.000 Lumen
- Contrasto dinamico: 1.300:1
- Formato immagine: 16:9
- Dimensione immagine: da 60" a 100"
- Distanza di proiezione: 20 / 40 cm
- Risoluzione nativa: Full HD 1.080p
- Risoluzione compatibile: UHD 2.160p
- Wireless, Wi-Fi 6: 5G + 2,4G
- Regolazione del trapezio: Digitale, regolazione 4 punti tramite telecomando
- Messa a fuoco: Digitale, manuale o automatica
- IN/OUT: USB, HDMI, Audio OUT Analog+Digital, Ethernet
- Consumo: 35 W
- Ingresso alimentazione: DC 19V 3,42A 64,98W
- Dimensioni: 31 x 18,3 x 6,9 cm
- Peso: 1,85 Kg
- Sistema operativo basato su Android Open Source Project (AOSP)
- Altri servizi proprietari Google non sono inclusi

Contenuto della confezione

- 1 x Laser TV
- 1 x Telecomando (batterie: 2 x AAA non incluse)
- 1 x Manuale dell'utente
- 1 x Cavo di alimentazione
- 1 x Cavo HDMI



Sistema operativo basato su

Android Open Source Project (AOSP)

Altri servizi proprietari Google non sono inclusi

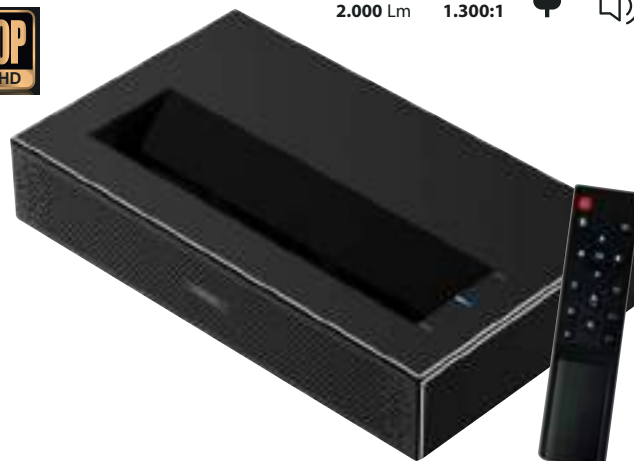

Art. 558100550

€ 1.095,18 M.O.: 1

SMALL PORTABLE



1080P FULL HD

4K Support



Auto FOCUS



AUTO Keystone



Mirroring



2.000 Lm



1.300:1



Wireless



VDP-IR250HD IRRADIO, LA RIVOLUZIONE SMART NELLA VIDEOPROIEZIONE

Compatto, leggero e incredibilmente potente: il VDP-IR250HD è il videoproiettore SMART progettato per chi vuole il massimo del grande schermo ovunque. Con Android TV 11 certificato Google e una pratica custodia antiurto inclusa, lo spettacolo viaggia sempre con te.

- **Schermo gigante:** Crea immagini immersive da 40" fino a un'enorme diagonale di 250".
- **Luminosità ed eleganza:** Con ben 5.000 Lumen e un contrasto di 20.000:1, offre immagini brillanti in una scocca dal design minimale e moderno.
- **Intrattenimento smart:** Accedi a tutte le tue app di streaming preferite direttamente dalla Home Page o scaricale dal Google Play Store.
- **Pronto in un attimo:** Grazie alla regolazione automatica del trapezio e della messa a fuoco, ottieni un'immagine geometricamente perfetta su qualsiasi superficie (muri, schermi o soffitti).

Caratteristiche principali

- Sorgente luminosa: LED Osram (made in Germany)
- Pannello: LCD 4,5 pollici
- Gamma colori: 17.600
- Durata del LED: 40.000 ore
- Luminosità proiettore: 350 ANSI / 5.000 Lumen
- Contrasto dinamico: 20.000:1
- Dimensione immagine: 40 - 250 pollici
- Distanza di proiezione: 1,1 - 4,5mt
- Risoluzione nativa: HD 1080p / 1920 x 1090 px
- Risoluzione supportata: UHD 4K 2160p / 4096 x 3840px
- Wireless, Wi-Fi: 5G + 2,4G
- IN/OUT: USB, HDMI, AV IN, Audio OUT
- Regolazione del fuoco: Elettronico ed automatico
- Correzione del trapezio: Elettronico ed automatico
- Attacco per treppiede: tipo UNC1/4
- Ingresso alimentazione: 19VDC / 100-240V~50/60Hz
- Dimensioni prodotto (LxAxP): 210 x 165 x 130mm

Contenuto della confezione

- 1 * Proiettore HD/4k
- 1 * Telecomando (2 x AAA non incluse)
- 1 * Manuale dell'utente
- 1 * Alimentatore 19V DC
- 1 * Borsa da trasporto antiurto



1080P FULL HD



AUTO Keystone



5000 Lm



20000:1



Wireless

Art. 558100334

€ 640,50 M.O.: 1

VDP-IR SMART 900 HD, Videoproiettore SMART 900 ANSI

Scopri il videoproiettore smart basato su sistema operativo Android Open Source Project (AOSP), perfetto per trasformare ogni spazio in un'esperienza di intrattenimento immersiva. Grazie alla risoluzione nativa Full HD 1080p e al supporto 4K, garantisce immagini nitide e dettagliate. Offre una luminosità straordinaria di 900 ANSI lumen (3.000 lumen), tra le più elevate della sua categoria.

Perfetto per installazioni fisse in ambito home entertainment e professionale, grazie alla sua leggerezza e alle dimensioni compatte è ideale anche per un utilizzo portatile. Dotato di messa a fuoco automatica ed elettronica (regolabile anche da telecomando) e correzione automatica del trapezio, è pensato per un utilizzo semplice e immediato.

Massima connettività: ingresso HDMI e porta USB con media player integrato per la riproduzione di video, musica e foto. È possibile collegare facilmente qualsiasi dispositivo AV compatibile. Anche se dotato di speaker stereo 2*5W, con la funzione Wireless OUT o tramite jack audio da 3,5 mm, puoi connettere speaker esterni per un audio ancora più potente.

Grazie al WiFi dual band 2.4G/5G e alla funzione di mirroring, puoi trasmettere contenuti direttamente da smartphone o tablet in streaming fluido e senza latenze, sia audio che video.

Caratteristiche principali

- Colore: Dark grey
- Display: LCD
- Gamma colori: 17.600
- Durata del LED: 50.000 ore
- Luminosità proiettore: 900 ANSI / 3.000 Lm
- Contrasto dinamico: 3.000:1
- Formato | Dimensione immagine: 16:9, 4:3 | 50" / 250"
- Distanza di proiezione: 1,6 / 6,3 mt
- Risoluzione nativa | compatibile: Full HD 1.080p | UHD 2.160p
- Wireless, Wi-Fi: 5G + 2,4G
- IN/OUT: USB, HDMI, AV IN, Audio OUT
- Regolazione del trapezio: Automatica
- Messa a fuoco: Automatica + elettronica tramite telecomando
- Alimentazione | Consumo: 100-240 V~50/60 Hz | 110 W
- Dimensioni: 256 x 219 x 109 cm
- Peso: 2,1 Kg
- **Sistema operativo basato su Android Open Source Project (AOSP)**
Altri servizi proprietari Google non sono inclusi

Contenuto della confezione

- 1 x Proiettore
- 1 x Telecomando (batterie: 2 x AAA non incluse)
- 1 x Manuale dell'utente
- 1 x Cavo di alimentazione
- 1 x Cavo HDMI

Art. 558100432
€ 354,38 M.O.: 1



Sistema operativo basato su

Android Open Source Project (AOSP)

Altri servizi proprietari Google non sono inclusi



1080P FULL HD

4K Support



Auto FOCUS



AUTO Keystone



Mirroring



3.000 Lm



3.000:1



Wireless



VDP-IR SMART 600 HD, Videoproiettore SMART 600 ANSI

Porta il cinema ovunque vuoi con il nuovo VDP-IR Smart 600 HD: il videoproiettore smart Full HD 1080p con supporto 4K di Irradio, basato su Android Open Source Project. Compatto ma potente, offre immagini nitide e brillanti con una luminosità di 600 ANSI lumen, tra le più alte della categoria.

Perfetto per film, gaming, eventi e presentazioni, è leggero, maneggevole e facile da usare grazie all'autofocus elettronico, correzione automatica del trapezio e controllo remoto. Con HDMI, USB, media player integrato, jack audio e funzione Wireless OUT, garantisce massima compatibilità e audio potente con speaker esterni. Il WiFi dual band 2.4G/5G e il mirroring ti permettono di trasmettere contenuti da smartphone o tablet senza ritardi.

Audio immersivo con speaker integrati di qualità e massima libertà di proiezione grazie allo stand orientabile a 180°/360°, ideale per pareti e soffitti.

Caratteristiche principali

- Colore: Dark grey
- Display: LCD
- Gamma colori: 17.600
- Durata del LED: 50.000 ore
- Luminosità proiettore: 600 ANSI / 2.000 Lm
- Contrasto dinamico: 3.000:1
- Formato | Dimensione immagine: 16:9, 4:3 | 40" / 250"
- Distanza di proiezione: 1 / 5,2 mt
- Risoluzione nativa | compatibile: Full HD 1.080p | UHD 2.160p
- Wireless, Wi-Fi: 5G + 2,4G
- IN/OUT: USB, HDMI, AV IN, Audio OUT, Ethernet
- Regolazione del trapezio: Automatica
- Messa a fuoco: Automatica + elettronica tramite telecomando
- Alimentazione | Consumo: 100-240 V~50/60 Hz | 90 W
- Attacco per treppiede: tipo UNC1/4
- Dimensioni: 224,5 x 185 x 101 cm
- Peso: 1,35 Kg
- **Sistema operativo basato su Android Open Source Project (AOSP)**
Altri servizi proprietari Google non sono inclusi

Contenuto della confezione

- 1 x Proiettore
- 1 x Telecomando (batterie: 2 x AAA non incluse)
- 1 x Manuale dell'utente
- 1 x Cavo di alimentazione
- 1 x Cavo HDMI
- 1 x Supporto da tavolo



1080P FULL HD

4K Support



Auto FOCUS



AUTO Keystone



Mirroring



2.000 Lm



3.000:1



Wireless



Sistema operativo basato su

Android Open Source Project (AOSP)

Altri servizi proprietari Google non sono inclusi

Art. 558100431
€ 234,56 M.O.: 1



VDP-IR SMART 150HD, VIDEOPROIETTORE SMART 150 ANSI

VDP-IR Smart 150HD è il Videoproiettore Smart con Android TV versione 13 OS, in tecnologia LCD ed illuminazione a LED, con risoluzione max Full HD 1080p. Portalo sempre con te e goditi lo spettacolo cinematografico ovunque vuoi, proietta su schermo o su qualsiasi superficie, non richiede alcuna installazione, grazie alla regolazione elettronica della messa fuoco e della correzione ortogonale dell'immagine, puoi posizionare VDP-IR Smart 150HD ovunque, penserà a tutto lui. In dotazione un pratico stand orientabile.

Caratteristiche principali

- Display: LCD
- Durata del LED: 30.000 h
- Luminosità proiettore: 150 ANSI / 500 Lm
- Contrasto dinamico: 2.000:1
- Formato immagine: 16:9, 4:3
- Dimensione immagine: 60" / 100"
- Distanza di proiezione: 0,5 / 5,6 mt
- Risoluzione nativa: HD 1280*720p
- Risoluzione compatibile: Full HD 1920*1080p
- Wireless, Wi-Fi: 5,8G + 2,4G
- IN/OUT: USB, HDMI, Audio OUT
- Regolazione del trapezio: Automatica
- Messa a fuoco: Elettronica tramite telecomando
- Consumo: 50 W
- Ingresso Alimentazione: 100-240 V~50/60 Hz
- Attacco per treppiede: tipo UNC1/4
- Dimensioni: 190 x 128 x 116 mm (incluso supporto)
- Peso: 0,71 Kg

• Sistema operativo basato su Android Open Source Project (AOSP)
Altri servizi proprietari Google non sono inclusi

Contenuto della confezione

- 1 x Proiettore
- 1 x Telecomando
- (batterie: 2 x AAA non incluse)
- 1 x Manuale dell'utente
- 1 x Cavo di alimentazione



Sistema operativo basato su

Android Open Source Project (AOSP)

Altri servizi proprietari Google non sono inclusi



1080P FULL HD Wireless



Auto FOCUS



AUTO Keystone



Mirroring



500 Lm



2.000:1



VDP-IR Smart 150HD Black
Art. 55810043
€ 87,75 M.O.: 1

VDP-IR Smart 150HD White
Art. 558100438
€ 87,75 M.O.: 1

Home & Business



180x180cm

IR-S1180RN
SCHERMO TRIPOD

Tipo: Treppiede
Telo: balta bianca retro nero, in PVC
Certificato ignifugo: M1
Formato: 1:1
Pollici: 95

Art. 558000500
€ 218,56 M.O.: 1



SCHERMI MANUALI

Tipo: manuale
Telo: balta bianca retro nero, in PVC
Certificato ignifugo: M1
Formato: 16:9

ARTICOLO	MODELLO	DIMENSIONE	M.O.	PREZZO €
558000501	IR-S3202RN	200 x 113 cm	1	371,76
558000502	IR-S3242RN	240 x 135 cm	1	434,86
558000503	IR-S3302RN	300 x 170 cm	1	561,03

SCHERMI MOTORIZZATI

Tipo: motorizzato con cassone bianco
Telo: balta bianca retro nero, in PVC
Certificato ignifugo: M1
Formato: 16:9

ARTICOLO	MODELLO	DIMENSIONE	M.O.	PREZZO €
558000504	IR-S4202RN	200 x 113 cm	1	962,08
558000505	IR-S4242RN	240 x 135 cm	1	1.124,31

Smart TV Irradio

Intrattenimento senza confini, a casa come in viaggio.

Se cerchi la perfetta combinazione tra tecnologia smart e massima versatilità, la nuova gamma di televisori risponde a ogni tua esigenza di spazio e intrattenimento.

Dal salotto di casa fino ai tuoi viaggi in camper, questi tre modelli sono progettati per offrirti immagini nitide, un utilizzo intuitivo e tutta la libertà che desideri

Alimentazione 12 V DC 100-240 V AC 50/60 Hz
Adattatore 12V 3A e cavo accendisigari inclusi



NOVITÀ



Art. 217000008
€ 299,24 M.O.: 1

IR19VBA1 Smart TV 19" AC/DC VIDAA

Power by
VIDAA

19"

- DLED | HEVC Main 10
- Risoluzione: 1366x768 | 16/9
- Contrasto 3000:1
- DVB-T2/S2/C
- Sistema Operativo VIDAA (Linux)
- Televideo | Parental control
- 3 ingressi HDMI 1.4 | 2 x USB 2.0
- Uscite: audio digitale ottica | cuffie jack
- Audio 2x5 Watt | Tecnologia Audio: Dolby Audio
- Classe Energetica: F | Consumo 45 Watt
- LCN channeling
- EPG
- Telecomando con funzioni smart (batterie non incluse)



Art. 217000000
€ 225,14 M.O.: 1

IR24TBA1 Smart TV 24" AC/DC Tizen

Power by
TIZEN*

24"

- DLED | HEVC Main 10
- Risoluzione: 1366x768 | 16/9
- Contrasto 2000:1
- DVB-T2/S2/C
- Sistema Operativo TIZEN (Samsung)
- Teletext | Parental control
- 3 ingressi HDMI 1.4 | 2 x USB 2.0
- Uscita audio digitale ottica
- Audio 2x3 Watt | Tecnologia Audio: Dolby Audio
- Classe Energetica: F | Consumo 16,5 Watt
- LCN channeling
- EPG
- CPU ARM CA53 Quad-core
- Telecomando con funzioni smart (batterie non incluse)



Art. 217000001
€ 282,14 M.O.: 1

IR32TBA1 Smart TV 32" AC/DC Tizen

Power by
TIZEN*

32"

- DLED | HEVC Main 10
- Risoluzione: 1366x768 | 16/9
- Contrasto 3000:1
- DVB-T2/S2/C
- Sistema Operativo TIZEN (Samsung)
- Teletext | Parental control
- 3 ingressi HDMI 1.4 | 2 x USB 2.0
- Uscita audio digitale ottica
- Audio 2x8 Watt | Tecnologia Audio: Dolby Audio
- Classe Energetica: F | Consumo 25 Watt
- LCN channeling
- EPG
- CPU ARM CA53 Quad-core
- Telecomando con funzioni smart (batterie non incluse)



Smart TV Irradio

Il cuore dell'intrattenimento domestico: eleganza, velocità e visione senza confini.

La gamma si completa con due modelli da 32 e 40 pollici, progettati per l'installazione fissa in casa, in ufficio o in strutture ricettive. Caratterizzati da una tradizionale alimentazione a 220V, questi televisori puntano su pannelli più ampi e su una potenza di calcolo ottimizzata grazie ai processori Quad-core, garantendo un'esperienza multimediale fluida e d'impatto.



IR32VAA2 Smart TV 32" AC VIDAA

Powered by
VIDAA

32"

Art. 217100005

€ 256,49 M.O.: 1

- DLED
- HEVC Main 10
- 16/9
- Risoluzione 1366x768
- Contrasto 3000:1
- DVB-T2/S2/C
- Sistema Operativo VIDAA (Hisense)
- Teletext
- 3 ingressi HDMI 1.4
- Uscita audio digitale Ottica
- Uscita cuffie jack
- Audio 2x8 Watt
- Tecnologia Audio: Dolby Audio
- LCN channeling
- EPG

- CPU ARM CA53 Quad-core
- Processore grafico Mali-G52-2EE MC1
- Angolo visuale 178° x 178°
- Retroilluminazione 30.000 ore
- Doppia porta USB 2.0
- Connessione LAN cablata
- Formati supportati: MPEG-1/2/4, H264, AVI, MP3, FLAC
- Parental control
- Timer accensione/spengimento
- Alimentazione 100-240 V AC 50/60 Hz
- Classe Energetica: F
- Consumo 48 Watt
- Aggancio VESA: 200 x 150 mm standard
- Telecomando con funzioni smart
- Batterie telecomando non incluse



IR40VAB2 Smart TV 40" AC VIDAA

Powered by
VIDAA

40"

Art. 217100006

€ 356,23 M.O.: 1

- DLED
- HEVC Main 10
- 16/9
- Risoluzione 1366x768
- Contrasto 3000:1
- DVB-T2/S2/C
- Sistema Operativo VIDAA (Hisense)
- Teletext
- 3 ingressi HDMI 1.4
- Uscita audio digitale Ottica
- Uscita cuffie jack
- Audio 2x8 Watt
- Tecnologia Audio: Dolby Audio
- LCN channeling
- EPG

- CPU ARM CA53 Quad-core
- Processore grafico Mali-G52-2EE MC1
- Angolo visuale 178° x 178°
- Retroilluminazione 30.000 ore
- Doppia porta USB 2.0
- Connessione LAN cablata
- Formati supportati: MPEG-1/2/4, H264, AVI, MP3, FLAC
- Parental control
- Timer accensione/spengimento
- Alimentazione 100-240 V AC 50/60 Hz
- Classe Energetica: F
- Consumo 48 Watt
- Aggancio VESA: 200 x 150 mm standard
- Telecomando con funzioni smart
- Batterie telecomando non incluse

Classic line



IR-M3 Classic
Diffusore wireless da 10W
IPX7, Funzione True Wireless Stereo
Riproduzione musica da USB esterno
LED RGB
Dimensioni: 10,1 x 10,2 x 4,8 cm
Peso netto: 306 g

Art. 550922100
€ 57,50 M.O.: 1



IR-M5 Classic
Diffusore wireless da 28W
IPX7, Funzione True Wireless Stereo
Riproduzione musica da USB esterno
LED RGB
Dimensioni: 17,4 x 8,0 x 5,3 cm
Peso netto: 506 g

Art. 550922101
€ 90,25 M.O.: 1



IR-M6 Classic
Diffusore wireless da 56W
IPX7, Funzione True Wireless Stereo
Riproduzione musica da USB esterno
LED RGB
Dimensioni: 24,6 x 8,8 x 9,71 cm
Peso netto: 1,73 Kg

Art. 550922102
€ 118,46 M.O.: 1



IR-M9 Charge Classic
Diffusore wireless da 28W
IPX7, Funzione True Wireless Stereo
Ricarica wireless per Smartphones + Magsafe
Dimensioni: 22,2 x 7,5 x 8,5 cm
Peso netto: 856 g

Art. 550922103
€ 115,65 M.O.: 1



IR-203 Sound+
Diffusore wireless da 3.5W RMS
Riproduzione da USB esterno,
Driver attivo 50mm wide range
Dimensioni: 9.2 x 9.3 x 4.5 cm
Peso: 183 g

Art. 550922126
€ 14,00 M.O.: 1



IR-SK800BT
Diffusore wireless da 4W IPX4,
Funzioni: Wireless, AUX, TF, FM, USB,
TWS, Assistente vocale, chiamate in
vivavoce
Dimensioni: 9.2 x 9.3 x 4.5 cm
Peso: 183 g

Art. 550922125
€ 32,00 M.O.: 1



Diffusori wireless

Piccoli, colorati, portatili e potenti: i compagni ideali ovunque tu vada.

Resistenti ad acqua e polvere (IPX6), costruiti con materiali di qualità alloggiando, al loro interno, un driver full range da 50 mm per 5W di potenza effettiva e un risonatore passivo, che rendono il suono ricco ed equilibrato.

ARTICOLO	MODELLO	M.O.	PREZZO €
550922105	IR-G30 Nero	1	36,00
550922106	IR-G30 Rosso	1	36,00
550922107	IR-G30 Blu	1	36,00
550922108	IR-G30 Verde	1	36,00



HOME AUDIO - DIFFUSORI WIRELESS



IR-M65
Diffusore wireless da 5W
IPX7, Funzioni: Wireless, AUX,
Micro SD, chiamate in vivavoce
Dimensioni: 9,6 x 9,6 x 20 cm
Peso netto: 200 g

Art. 550922112
€ 45,00 M.O.: 1



IR-D5
Diffusore wireless da 5W
Caricabatterie wireless per smartphone,
tablet e smartwatch compatibile con
sistemi iOS e Android
Dimensioni: 9,4 x 9,4 x 11,4 cm
Peso netto: 400 g

Art. 550922113
€ 52,00 M.O.: 1



IR-E100L | IR-E200L | IR-E300L
Diffusori wireless resistenti all'acqua: IPX7
adatti per uso bordo piscina
Funzione True Wireless Stereo, Illuminazione LED RGB
Dotati di doppio driver full range e due subwoofer
passivi (solo IR-E200L e IR-E300L)

ARTICOLO	MODELLO	POTENZA	FUNZIONI	DIMENSIONI CM PESO GR	M.O.	PREZZO €
550922114	IR-E100L	10W	Wireless, AUX IN, TF	9,4 x 9,0 x 11 / 300	1	50,00
550922115	IR-E200L	20W	Wireless, AUX IN, TF, microfono integrato	7,6 x 8,0 x 18 / 553	1	75,00
550922116	IR-E300L	42W		9 x 9,4 x 21 / 880	1	85,00



IR-M685Boost
Diffusore wireless da 25W
IPX6, Funzioni: AUX IN, TF, USB
True Wireless Stereo,
Illuminazione LED RGB
Dimensioni: 9,5 x 9,5 x 24 cm
Peso netto: 800 g

Art. 550922130
€ 105,00 M.O.: 1



IR-P6
Diffusore wireless da 60W
IPX4, Funzioni: True Wireless Stereo,
AUX IN, TF, USB, Illuminazione LED RGB
Dimensioni: 18 x 20,5 x 39,7 cm
Peso netto: 5 Kg

Art. 550922132
€ 180,00 M.O.: 1

IR-P4
Diffusore wireless da 40W
IPX4, Funzioni: True Wireless Stereo,
AUX IN, TF, USB, Illuminazione LED RGB
Dimensioni: 33 x 12,5 x 14 cm
Peso netto: 2 Kg

Art. 550922131
€ 110,00 M.O.: 1



HOME AUDIO - BOOMBOX

IR-G600
Boombox da 55W
IPX7, Funzioni: True Wireless Stereo
Equalizzazione (Bass booster)
AUX IN, TF, USB, Illuminazione LED RGB
Riproduzione Mp3, WAV da USB esterno
Dimensioni: 9,8 x 14,3 x 13,6 cm
Peso netto: 2,315 Kg

Art. 550922117
€ 148,00 M.O.: 1



IR-H60
Boombox da 20W
IPX6, Funzioni: True Wireless Stereo
Riproduzione musica da dispositivo USB esterno
AUX IN, USB, Illuminazione LED RGB
Dimensioni: 28,1 x 12,3 x 15,9 cm
Peso netto: 600 g

Art. 550922133
€ 105,00 M.O.: 1

IR-H68
Boombox da 50W
IPX6, Funzioni: True Wireless Stereo
Riproduzione musica da dispositivo USB esterno
Equalizzazione (alti, medi, bassi)
AUX IN, USB, Illuminazione LED RGB
Dimensioni: 31,4 x 18 x 13,4 cm
Peso netto: 1,7 Kg

Art. 550922134
€ 138,00 M.O.: 1



HOME AUDIO – BOOMBOX

NOVITÀ

IRRADIO
Play the future



IR-G650

Boombox da 60W
IPX6, Funzioni: True Wireless Stereo
Power bank, Equalizzazione (alti, medi, bassi)
Riproduzione musica da dispositivo USB esterno
AUX IN, USB, Illuminazione LED RGB
Dimensioni: 46,5 x 26,3 x 19,8 cm
Peso netto: 4,7 Kg

Art. 550922135
€ 230,00 M.O.: 1



IR-G710V

Boombox da 100W
IPX6, Funzioni: True Wireless Stereo
Power bank, Equalizzazione (Bass booster)
Riproduzione MP3, WAV da dispositivo USB
esterno, AUX IN, USB, Illuminazione LED RGB
Dimensioni: 49,6 x 21,4 x 20,4 cm
Peso netto: 4,98 Kg

Art. 550922109
€ 295,00 M.O.: 1

HOME AUDIO – PARTY SPEAKER

IR-K5 Deep Sound

Party speaker da 40W
IPX5, Funzioni: True Wireless Stereo
Equalizzazione (alti, medi, bassi)
Riproduzione musica da
USB -mini SD esterno
AUX IN, USB, Illuminazione LED RGB
Dotato di microfono wireless
Dimensioni: 17,4 x 16,1 x 21,6 cm
Peso netto: 1,92 Kg



Art. 550922119
€ 151,00 M.O.: 1

IR-PS40 Power1

Party speaker da 40W
Funzioni: True Wireless Stereo
Equalizzazione con illuminazione
LED RGB, DSP simulator
Alloggio per tablet e smartphone
Ingressi: microfonico, AUX, SD, USB
Dotato di microfono wireless
Dimensioni: 24,2 x 29,4 x 24,4 cm
Peso netto: 3,2 Kg



Art. 550922120
€ 157,00 M.O.: 1

IR-PS60 Starlight

Party speaker da 60W
Funzioni: True Wireless Stereo
Equalizzazione con illuminazione
LED RGB, Luci laser RGB + proiezione
motivi decorativi (apertura 90°)
Supporta la funzione power bank
Dotato di microfono wireless,
cablato e telecomando
Dimensioni: 23,7 x 37,3 x 22,8 cm
Peso netto: 4,46 Kg



Art. 550922122
€ 250,00 M.O.: 1

IR-PS80 Omnia4

Party speaker da 80W
Diffusione del suono a 360° grazie a 4 diffusori
Funzioni: True Wireless Stereo
Equalizzazione con illuminazione LED RGB
Funzione power bank, Dotato di microfono
wireless, cablato e telecomando
Dimensioni: 29,6 x 74,8 x 31,4 cm
Peso netto: 11,1 Kg



Art. 550922121
€ 320,00 M.O.: 1

IR-PS100 Starblast

Party speaker da 100W, IPX4
Funzioni: True Wireless Stereo
Equalizzazione con illuminazione
LED RGB, Luci laser RGB + proiezione
motivi decorativi (apertura 90°)
Funzione power bank
Dimensioni: 33,2 x 71,5 x 32,4 cm
Peso netto: 12,1 Kg



Art. 550922123
€ 400,00 M.O.: 1





**IR-H655BT
ANC/ENC/GAMING**
Cuffia Hi-Fi con funzione di cancellazione attiva del rumore e ambientale (ANC/ENC / Trasparente)*
Funzione gaming per azzerare le latenze
Pieghevole per la massima portabilità

Art. 141901039
€ 82,00 M.O.: 1



IR-H606BT PRO
Cuffia hi-fi wireless ibrida ANC/ENC
Cancellazione attiva del rumore e ambientale: ANC/ENC/Trasparente
ANC ibrido: FF+FB
Touch Control: priva di tasti si gestisce tutto con un tocco

Art. 141901040
€ 68,00 M.O.: 1



IR-GT-V15 PRO
Cuffia stereo wireless con ANC.
Cancellazione attiva del rumore:
ANC ibrido: FF+FB, pieghevole con finitura soft touch

Art. 141901041
€ 57,00 M.O.: 1



IR-TW929 Pro GAMING PRO
Auricolare wireless Hi-Fi e gaming di alta qualità con funzione ibrida ANC / ENC/Trasparente*, di cancellazione attiva del rumore ambientale
Tempo di riproduzione 7,4 h (100% volume)

Art. 141901044
€ 50,00 M.O.: 1



IR-TW958 PRO ANC/ENC
Auricolare wireless Hi-Fi di alta qualità con funzione ibrida ANC/ENC, di cancellazione attiva del rumore ambientale
Tempo di riproduzione 7 h (60% volume)

Art. 141901042
€ 57,00 M.O.: 1



IR-SIGMA PLUS
Set Cuffia TV 2,4GHz + BT
• Frequenza portante: 2,4 GHz
• Altoparlante: Wide-band 40 mm
• Risposta in frequenza: 60 Hz – 20 KHz
• Ingresso Aux-in: Jack3,5 mm
• Ingresso digitale: Connessione Toslink SP/Dif in fibra ottica segnale PCM

IR-SIGMA
Cuffia aggiuntiva per il set IR-SIGMA PLUS (141901050)



ARTICOLO	MODELLO	TIPO	M.O.	PREZZO €
141901050	IR-SIGMA PLUS	Set cuffia + ricevitore	1	143,00
141901051	IR-SIGMA	cuffia aggiuntiva	1	86,00



IR-BETA PRO
KIT Audio Wireless 2,4Ghz trasmettitore + ricevitore
Trasmissione fino a 20 mt
16 livelli di regolazione del volume
IN analogico: Jack 3,5 mm
IN digitale: SP/Dif PCM su connessione Toslin

Art. 141901052
€ 72,00 M.O.: 1



VisionAI

Occhiali Smart VisionAI con telecamera 8MP, assistente AI, traduzione in tempo reale

CARATTERISTICHE TECNICHE

- Traduzione in tempo reale
- Foto e video 8MP e 1200P
- Assistente AI tramite ChatGPT
- Riproduzione musica (Open Ear)
- Chiamate Bluetooth
- Registrazione audio tramite microfono integrato
- Sistemi supportati: Android / Windows / iOS
- Wireless 5.4
- Autonomia in chiamata: 15 ore
- Autonomia in riproduzione musicale: 8 ore
- Baeria ai polimeri di Li-ion: 3.8 V 290 mAh
- Memoria interna: 16 GB
- Microfoni in silicone con cancellazione del rumore
- Touch Control
- Alimentatore non incluso
- Dimensioni: 14,1 x 15,4 x 4,1cm



VisionAI Clear

Art. 168700000
€ 122,54 M.O.: 1



VisionAI Dark

Art. 168700001
€ 131,09 M.O.: 1



Real-time translation



8MP / 1200P



AI assistant via ChatGPT



Music playback (Open Ear)



Bluetooth calls



Audio recording

HOME AUDIO - RADIO DAB

IR-Pocket

Radio tascabile AM/FM con antenna telescopica e speaker integrato è l'ideale per ascoltare la tua musica e le tue stazioni preferite ovunque tu sia!

Art. 212400000
€ 22,00 M.O.: 1



IR-Clock

Con radio FM, doppia sveglia e display LED regolabile, questa radiosveglia è la compagna ideale per iniziare e concludere la giornata con serenità.

Art. 212400001
€ 29,00 M.O.: 1



NOVITÀ

IR-CrystalSound
Giradischi 33, 45 e 78 giri wireless con USB recording

- Velocità di rotazione: 33 / 45 / 78 RPM
- Adattatore per dischi 45 RPM incluso
- Funzione auto stop
- Bluetooth: versione 5.3
- Registrazione e riproduzione audio tramite USB esterno (non fornito)
- Altoparlanti integrati: 2 x 3W
- Uscita RCA stereo
- Alimentazione: 5V DC 1A

Art. 215600000
€ 99,74 M.O.: 1

IR-RetroCase
Giradischi portatile a valigetta con 3 velocità

- Velocità di rotazione: 33 / 45 / 78 RPM
- Adattatore per dischi 45 RPM incluso
- Funzione auto stop
- Ingresso AUX
- Bluetooth: versione 5.3
- Registrazione e riproduzione audio tramite USB esterno (non fornito)
- Altoparlanti integrati: 2 x 3W
- Uscita cuffie
- Alimentazione: 5V DC 1A
- Design a valigetta per un facile trasporto

Art. 215600001
€ 91,19 M.O.: 1

IR-VinylPower
Giradischi con 2 altoparlanti esterni

- Velocità di rotazione: 33 / 45 / 78 RPM
- Adattatore per dischi 45 RPM incluso
- Funzione auto stop
- Tecnologia Wireless Audio BT IN versione 5.4
- Altoparlanti stereo esterni da 30W
- Registrazione e riproduzione audio tramite USB esterno (non fornito)
- Uscita audio RCA
- Alimentazione: AC 100-240V 50/60Hz > DC 12V 2A
- Colore: effetto legno nero

Art. 215600002
€ 142,49 M.O.: 1

RP162
GIRADISCHI HI-FI HQ CON BT

Giradischi versatile con streaming bluetooth e ingresso USB, dotato di un solido alloggiamento in legno massello fatto a mano. Velocità di riproduzione: 33, 45 e 78 giri

Art. 550923829
€ 227,04 M.O.: 1
audizio



**AV360BT
MINI AMPLIFICATORE**
2x40W BT/SD/USB/MP3



Art. 550923787
€ 87,48 M.O.: 1



**PDC30
AMPLIFICATORE PA 30W 12V/220V**
Amplificatore per mezzi mobili 4 Ohm, con ingressi microfonici, BT, MicroSD, USB



Art. 550923960
€ 112,74 M.O.: 1



**AV-150BT
AMPLIFICATORE STEREO**
2 + 3Ch 100W x 2 + 60W x 3, con USB e Bluetooth
Ottimo per Home Cinema e Karaoke



Art. 550923681
€ 161,78 M.O.: 1



Amplificatore PV240BT
4-80hm da 400W 4 zone (4 x 100W), con controllo del volume indipendente USB/SD e Bluetooth

Art. 550923685
€ 261,67 M.O.: 1



Amplificatore PV260BT
4-80hm da 600W 6 zone (6x 100W) con controllo del volume indipendente, USB/SD e Bluetooth

Art. 550923686
€ 307,17 M.O.: 1

**IR-DA3 TUBE
AMPLIFICATORE STEREO
HI-FI IBIDO VALVOLARE
40HM 50W RMS**
2x 25W RMS
USB e Bluetooth

Suono valvolare caldo e corposo dispone di una ricca dotazione di ingressi e uscite:

- 1 ingresso USB
- 2 ingressi AUX L/R RCA
- 2 ingressi digitali: coassiale ed ottico
- 1 uscita PRE OUT L/R RCA per la connessione con altro amplificatore
- 1 uscita SUB RCA
- 1 uscita cuffia con Jack da 3,5 mm

Art. 550111015
€ 225,00 M.O.: 1

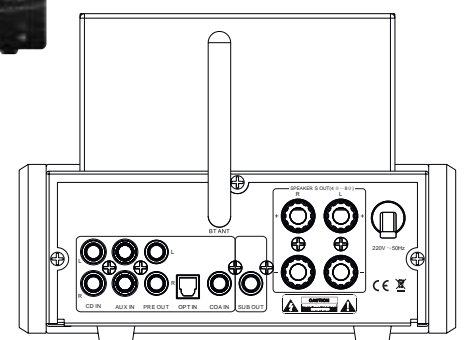



PHONO 120 W USB

MK-120SAS
AMPLIFICATORE STEREO
120W (2 x 60W), 40hm
 BT/SD/USB/MP3
 Ingressi: Phono/AUX/DVD/ USB/ 2 Microfonici
 Uscita: REC

Art. 550111011
€ 185,92 Q.tà: 1



PHONO SPDF COAX 200 W USB

MK-200SAS
AMPLIFICATORE STEREO
200W (2 x 100W), 40hm
 BT/SD/USB/MP3, ingressi microfonici
 linea RCA, Digitali: coassiale-ottico

Art. 550111012
€ 261,84 M.O.: 1



WOOFER IN KEVLAR

120 W

IRDP-65K PRO
Diffusori coppia passivi, 2 vie 120W
6.5" 40hm colore nero

Art. 550718450
€ 210,00 M.O.: 1



120 W
 WOOFER IN KEVLAR

MKDP-65K PRO
Diffusori coppia passivi
2 vie 120W 6.5" 40hm

ARTICOLO	MODELLO	COLORE	M.O.	PREZZO €
550718535	MKDP-65K PRO Black	Nero	1	189,26
550718536	MKDP-65K PRO Cherry	Cherry	1	189,26



60 W

MKDP-60
Diffusori coppia passivi
2 vie 60W 6" 60hm

ARTICOLO	MODELLO	COLORE	M.O.	PREZZO €
550718537	MKDP-60 Black	Nero	1	109,44
550718538	MKDP-60 Cherry	Cherry	1	109,44



SHFT60B
Diffusori a torre
(coppia)

Potenza 2x150W
Woofer 2x 6.5"

Art. 550923234
€ 324,96 M.O.: 1



**SISTEMA HOME
THEATRE 5.0**

Potenza max. 3x 50W + 2x 180W
rms 335w
Risposta in freq. 20hz - 20khz
Impedenza 4 ohm
Woofer 2x16 cm
Tweeter neodmium

Art. 550923231
€ 429,71 M.O.: 1

IRRADIO
Play the future



**IRDP-SUB100 PRO
SUBWOOFER**
amplificato ad alta
efficienza con woofer
da 10"

100
W

Art. 550718550
€ 220,00 M.O.: 1



**SHFS12B
SUBWOOFER**
attivo da 12"
classe D 400W

400
W

Art. 550923682
€ 460,83 M.O.: 1



AURICOLARI E CUFFIE



**Cuffia TV stereo
con regolazione
volume**

Cavo da 4,5mt

Art. 141901822
€ 9,61 M.O.: 1



**633-P Cuffia stereo
ad archetto cablata
ultra leggera**

Jack da 3,5mm

Art. 141901033
€ 4,59 M.O.: 5



melchioni
mkc

**CD-411
mini auricolari
stereo**

Jack 3,5 Mm

Art. 141901043
€ 3,60 M.O.: 5



DIFFUSORI WIFI E BLUETOOTH

KIT DIFFUSORI 952538 WS40A

Set di altoparlanti a 2 vie di alta qualità per uso interno ed esterno. Il set di altoparlanti è dotato di una funzione Wifi per collegarsi alla rete domestica e riprodurre musica con qualsiasi lettore supportato da airplay, dlna (android) o qplay.

È possibile combinare più gruppi di diffusori per una configurazione multi-room. C'è anche un ricevitore BT integrato per lo streaming di musica dal tuo smartphone.



FUNZIONI

Connessione Wifi per l'impostazione di più stanze
Ricevitore BT per streaming audio
Grado di protezione IP55
Sistema di altoparlanti a 2 vie
Uso interno ed esterno
Fornito per coppia
Staffe di montaggio fornite
Compreso il telecomando

SPECIFICHE

Pot. max. 2x 100w | Pot. rms 2x 25w
Risposta in frequenza 100hz - 20khz
spl @ 1 w / 1 m 87 Db
Woofers 4"
Tweeter 1/2" mylar dome
Tensione 100-240Vac 50/60Hz
Dim. per altoparlante 155x150x215mm
Peso per set 3,0 kg

Art. 550923150

€ 254,06 M.O.: 1

BT10 Amplificatore stereo compatto classe D

Il Modulo Amplificatore stereo da 30W, con Bluetooth consente di collegare diffusori a bassa impedenza (8 Ω): perfetto per i diffusori da soffitto e da parete. Il dispositivo può essere collegato a smartphone / tablet con connessione BT e tutta la musica riprodotta verrà trasmessa in streaming attraverso l'amplificatore 2x 15W incorporato.



Art. 550923153

€ 53,40 M.O.: 1

SPECIFICHE

Potenza di uscita: max 60W
Potenza in uscita: RMS 30W (2x15W)
Impedenza: 8Ω
Risposta in frequenza: 80Hz - 18.000Hz

Alim: 100-240Vca 50/60Hz (adat. 15V)
Consumo energetico: 0.4-0.2A
Dimensioni (LxPxA): 85x45x25mm
Peso: 0,16 kg
Fornito con alimentatore

Diffusori amplificati (coppia) da soffitto

Set di due diffusori da soffitto, 1 con amplificatore interno e 1 passivo che può essere connesso all'altoparlante attivo. Il ricevitore BT è l'ideale per lo streaming di musica senza fili agli altoparlanti. Ideali per l'utilizzo in salotti, zone di lavoro, garage, sale espositive, ristoranti etc.



SPECIFICHE

Set di 2 altoparlanti da soffitto
1 altoparlante attivo e 1 passivo
Amplificatore digitale incorporato
Ricevitore BT: streaming senza fili
Potenza max: 60W
Potenza RMS: 15W
Impedenza: 8 Ω

Woofers: 5.25"
Tweeter: 1" a cupola in seta
SPL: @ 1w/1m 86db
Diametro di montaggio: 175mm
Frequenza: 100hz-20khz
Dimensioni: 204vp x 80mm
Peso: 1.55kg

Art. 550923156

€ 112,26 M.O.: 1

WCS50 Diffusori amplificati (coppia) da soffitto

Coppia diffusori WI-Fi e Bluetooth da incasso a soffitto 100W 8Ω, colore bianco. È possibile combinare più gruppi di diffusori per una configurazione multi-room grazie all'app gratuita MÜZO per dispositivi iOS e Android.



SPECIFICHE

Potenza di uscita: max. 100W
Potenza in uscita: RMS 50W
Ø tweeter: 1" | Ø woofer: 5.25"
Impedenza: 8Ω
Risposta in frequenza: 70Hz - 20.000Hz
SPL: 1W / 1m 88dB
Diametro foro di montaggio: 180 mm Alim.:
100-240 V CA 50/60 Hz (adat. 19 V)
Dim. singolo altoparlante: ø 217x105mm Peso: 3 kg
Accessori: Telecomando, Cavo piattina

Art. 550923151

€ 294,93 M.O.: 1

ENTERTAINMENT DIFFUSORI PASSIVI



IP44

Diffusori (coppia)
passivi speaker marini
2 vie 2" 80W 8 ohm

Art. 550923146
€ 34,02 M.O.: 1

Diffusori (coppia)
passivi speaker marini
2 vie 6.5" 100W 8 ohm

Art. 550923147
€ 52,87 M.O.: 1



ODS40B
Coppia diffusori passivi 75W
80hm, neri

Art. 550923157
€ 44,59 M.O.: 1



SL6 DJ/PA
Coppia Diffusori
professionali PA
a 6" 250W 80hm

Art. 550923293
€ 174,17 M.O.: 1



Diffusori professionali PA

ARTICOLO	MODELLO	POTENZA	WOOFER	M.O.	PREZZO €
550923294	SL8	400 W	8"	1	111,56
550923295	SL10	500 W	10"	1	162,50
550923296	SL12	600 W	12"	1	219,69
550923297	SL15	800 W	15"	1	316,88



ENTERTAINMENT DIFFUSORI ATTIVI



Diffusore attivo Hi-End
Con ricevitore Bluetooth
e lettore mp3

ARTICOLO	MODELLO	POTENZA	WOOFER	M.O.	PREZZO €
550923193	SPJ-1200ABT	300 W	12"	1	315,48
550923194	SPJ-1500ABT	400 W	15"	1	477,36

SPJ-1000A
Diffusore attivo Hi-End

ARTICOLO	MODELLO	POTENZA	WOOFER	M.O.	PREZZO €
550923187	SPJ-1000A	400 W	10"	1	249,05
550923188	SPJ-1200A	600 W	12"	1	224,89
550923189	SPJ-1500A	800 W	15"	1	307,48

Supporti treppiede per diffusori
2 supporti + Borsa, tubo ø 35 mm
carico max 30 Kg, altezza max 160 cm



Art. 550923352
€ 80,24 M.O.: 1



ENTERTAINMENT SISTEMI PORTATILI

DIFFUSORE PROFESSIONALE

BT-USB-SD e 2 radiomicrofoni UHF
863.100 MHz
864.500 MHz



SPJ-PA915 Diffusore PA mobile c/2 microfoni

700 W
SD USB MP3/BT
UHF
863.100 MHz
864.500 MHz



Art. 550923038

€ 587,59 M.O.: 1

ARTICOLO	MODELLO	POTENZA	WOOFER	M.O.	PREZZO €
550923425	AP1200PA	600 W	12"	1	553,70
550923426	AP1500PA	800 W	15"	1	610,03

VX1000BT Sistema Full range attivo

1.000 W
2 Subwoofer da 12"
(attivo + passivo)
2 sarelliti medio-alti



Art. 550923167

€ 751,30 M.O.: 1



VX1200 Sistema Full range attivo

700 W
Subwoofer da 12"
(attivo)
sarellite medio-alti

Art. 550923166

€ 553,35 M.O.: 1



PA

Megafono MEG020

Potenza 20W
Portata 500 / 700m
con sirena
e funzione REC



Art. 550923127

€ 24,30 M.O.: 1

Megafono MEG040

Potenza 40W
Portata 700m / 1Km
con sirena
e funzione REC



Art. 550923128

€ 55,17 M.O.: 1

Megafono MEG065

Potenza 65W
Portata 1Km / 1,2Km
con sirena
e funzione REC



Art. 550923131

€ 101,98 M.O.: 1

VONYX

ENTERTAINMENT MIXER



STM-2300
Mixer passivo 2 canali
1 ingresso microfonico + 2
linea/stereo + USB mp3 player

Art. 550923058
€ 138,44 M.O.: 1



AM5A
Mixer Audio a 5 canali
con amplificatore DSP / BT /
SD USB / MP3

Art. 550923069
€ 432,16 M.O.: 1



Mixer Audio a 4 canali

	ARTICOLO	MODELLO	CARATTERISTICHE	M.O.	PREZZO €
1	550923053	VMM-P500	DSP / USB MP3 / BT	1	153,93
2	550923087	VMM-K402	ECO / DSP / USB MP3 / BT	1	186,43

VMM-F701

MIXER 7 canali con funzione eco, dsp.
Ingresso USB/SD MP3



USB

Art. 550923086
€ 195,15 M.O.: 1

MIXER 12 canali

con funzione eco, dsp.
ingresso USB MP3 e ricevitore
BLUETOOTH



Art. 550923090
€ 609,56 M.O.: 1



BT280
Faro PAR piatto ad alta potenza scocca abs,
luci LED 7x10W RGBAW-UV (6-in-1)



Art. 550923449
€ 191,28 M.O.: 1

BWA63
Faro PAR RGB in alluminio **IP65**



Art. 550923971
€ 130,30 M.O.: 1

DJ BANK 124 RGB
Effetto luce a fasci luminosi RGBW
dotato di due POD con 6 potenti LED

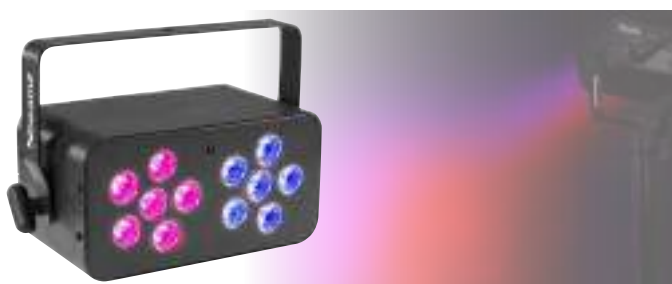

Art. 550923972
€ 138,95 M.O.: 1

JB90R
Mini Star Ball DMX LED 9 colori



Art. 550923970
€ 71,07 M.O.: 1

LEDWAVE
Luce LED con effetto jellyball
onda e ultravioletto



Art. 550923448
€ 156,56 M.O.: 1

S700-JB
Macchina crea fumo
+ LED Jelly Ball



Art. 550923541
€ 123,35 M.O.: 1

Luci laser, classe 3B
Multipoint Rosso / Verde
con microfono integrato 120mW



Art. 550923494
€ 54,51 M.O.: 1

BUV83
Barra LED a luce ultravioletta
30W, 8x3W UV



Art. 550923433
€ 61,10 M.O.: 1

DMX-512
Mini controller 64 canali DMX
con batteria ricaricabile
integrata da 9V
con autonomia ± 6-8 ore



Art. 550923975
€ 98,71 M.O.: 1

BUV45TL
Lampada a tubo UV con supporto
di fissaggio lunghezza 45cm



Art. 550923520
€ 52,72 M.O.: 1



Sfera a specchi e motore

ARTICOLO	TIPO	CARATTERISTICHE	M.O.	PREZZO €
550923509	sfera	20 ø 8"	1	39,43
550923510	sfera	30 ø 12"	1	84,36
550923511	motore	alim. 230Vac 50Hz	1	24,80
550923513	motore con 18 LED	alim. 3x AA 4,5V	1	29,78

Macchina crea fumo con luce LED
effetto fiamma, 700W, serbatoio da 250ml



Art. 550923540
€ 102,46 M.O.: 1

B500
Macchina crea bolle,
uso professionale
210x235x250 mm

Art. 550923555
€ 75,26 M.O.: 1



Lampada a risparmio energetico UV 25W E27



Art. 550923519
€ 15,31 M.O.: 1

Liquido per macchine crea fumo / bolle



ARTICOLO	DESCRIZIONE	M.O.	PREZZO €
550923559	bolle flacone da 1l	1	11,16
550923564	fumo alta densità 5l	1	25,00
550923566	fumo standard 1l	1	9,04



PA AMPLIFICATORI



MK1120D+
Amplificatore PA 120W
 USB/mp3 – wav player, radio FM
 e digitale DAB+, ricevitore Bluetooth

Art. 550111084
€ 333,64 M.O.: 1

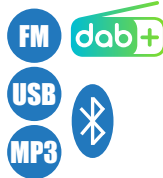

Amplificatori PA 6 zone

100V, 6 zone regolabili singolarmente con USB, MP3, radio FM e DAB+, Bluetooth

ARTICOLO	MODELLO	POTENZA	M.O.	PREZZO €
550111097	MK1206D+	120W	1	463,94
550111098	MK2406D+	240W	1	542,91
550111099	MK3506D+	350W	1	621,88



Power Dynamics
 Professional Audio

Amplificatori PA

70-100V 8Ω 12V con USB/SD e ricevitore Bluetooth

ARTICOLO	MODELLO	POTENZA	M.O.	PREZZO €
550923105	PPA30	30W	1	193,13
550923106	PPA50	50W	1	261,27



Amplificatori PA

100V/4-16Ω con Bluetooth e USB Media player e ingresso microfonico

ARTICOLO	MODELLO	POTENZA	M.O.	PREZZO €
550923070	PDM25	25 W	1	132,13
550923071	PDM45	45 W	1	161,07



Matrici PA

100V / 8 Ohm, 2 e 6 zone, con Bluetooth e USB Media player e ingresso microfonico

ARTICOLO	MODELLO	TIPO	POTENZA	M.O.	PREZZO €
550923113	PRM1202	5 IN x 2 OUT	2 x 120W	1	580,13
550923114	PRM606	4 IN x 6 OUT	6 x 60W	1	756,40



Amplificatori PA Mono zona 100V 80hm con BT, SD, USB
 4 zone 100V/ 80hm con BT, SD, USB, display LCD

ARTICOLO	MODELLO	TIPO	POTENZA	M.O.	PREZZO €
550923093	PRM60	mono zona	60W	1	277,08
550923094	PRM120	mono zona	120W	1	345,83
550923095	PRM240	4 zone	240W	1	412,79
550923096	PDV360MP3	4 zone	360W	1	502,04



Diffusorie a sospensione 30W 100V/80hm, Woofer da 5,25"

ARTICOLO	MODELLO	COLORE	M.O.	PREZZO €
550923175	PDS40B	nero	1	131,64
550923176	PDS40W	bianco	1	131,64



CL-130RT e CL-165RT Diffusori (coppia)
Rotondi da controsoffitto con trasformatore 100V, 8 Ohm colore bianco

ARTICOLO	POTENZA	Ø MM	M.O.	PREZZO €
550719040	25W	193	1	80,08
550719041	35W	208	1	106,77

CL-130ST Diffusori (coppia)
Rettilangolari da controsoffitto 25W c/ trasformatore 100V, 8 Ohm 173x204 mm colore bianco



Art. 550719042
€ 96,50 M.O.: 1



Coppia diffusori sonori
Interno / esterno IPX5
Woofer da 3"
Impedenza 100V/ 8Ω

ARTICOLO	POTENZA	COLORE	M.O.	PREZZO €
550923169	60W	nero	1	64,85
550923170	60W	bianco	1	66,10



Diffusori (coppia)
box bass reflex
8 Ohm IP44
con trasformatore 100V

ARTICOLO	MODELLO	POTENZA	COLORE	M.O.	PREZZO €
550718531	REF-30T	30W	nero	1	123,85
550718532	REF-30WHT	30W	bianco	1	123,85
550718533	REF-50T	50W	nero	1	174,51
550718534	REF-50WHT	50W	bianco	1	174,51

Coppia diffusori PA 100V- 80hm, IPX5

ARTICOLO	MODELLO	POTENZA	WOOFER TWEETER	COLORE	M.O.	PREZZO €
550923201	BC40V Black	100W	4" 3/4"	nero	1	120,25
550923202	BC40V White	100W	4" 3/4"	bianco	1	120,25
550923203	BC50V Black	120W	5.25" 3/4"	nero	1	159,62
550923204	BC50V White	120W	5.25" 3/4"	bianco	1	159,62
550923205	BC65V Black	150W	6.5" 1"	nero	1	175,94



Diffusori interno/esterno IPX5, impedenza 100V/ 8Ω

ARTICOLO	MODELLO	POTENZA	WOOFER	COLORE	M.O.	PREZZO €
550923171	952.126	30W	5"	bianco	1	225,51
550923172	952.128	30W	5"	nero	1	221,90
550923173	952.130	40W	6.5"	bianco	1	250,69
550923174	952.132	40W	6.5"	nero	1	250,69



GS-600 Diffusore a roccia colore grigio 30W 8Ω
Trasformatore 100V, da interno/esterno (IP65)
Potenza nom: 30W; musicale: 70W

Art. 550719052
€ 113,34 M.O.: 1



GS530 Diffusore sonoro verde da giardino 30W
Irradia il suono a 360°, Classe IPX5
Impedenza: 70V-100V, Woofer da 5.25"

Art. 550923143
€ 92,23 M.O.: 1



PA DIFFUSORI 80HM/100V

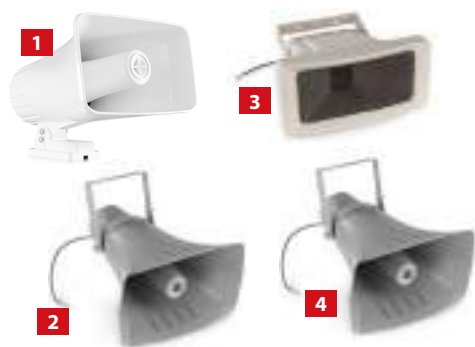

Diffusori sonori a tromba

	ARTICOLO	MODELLO	POTENZA	IP	CARATTERISTICHE	M.O.	PREZZO €
1	550923961	CH300	30W	IPX6	alta potenza, 8 Ohm	1	37,51
2	550923145	HS30	30W	IPX6	100V potenza selezionabile: 7,5 - 15 - 30W	1	117,50
3	550923149	HS30M	30W	IPX6	100V potenza selezionabile: 5 - 10 - 15 - 30W	1	123,86
4	550923148	HS40	40W	IPX6	100V potenza selezionabile: 10 - 20 - 40W	1	87,53

BASI MICROFONICHE

TM370
Base microfonica da tavolo
 Uscite: Jack da 6,3 mm, XLR (3 pin)

Art. 550923855
€ 86,78 M.O.: 1



TOUR GUIDE

TG40
Set Tour Guide Wireless

Set composto da trasmettitore con microfono ad archetto e ricevitore con cuffia auricolare
 Tecnologia di trasmissione digitale UHF avanzata
 Portata fino a 50m
 Durata della batteria: 5-10h

Art. 550923980
€ 121,12 M.O.: 1



TG40R
Solo Ricevitore per Set Tour Guide Wireless

È possibile abbinare un numero illimitato di ricevitori audio TG40R al set TG40 Tour Guide
 Facile da usare, tempo di configurazione veloce
 Tecnologia di trasmissione digitale UHF avanzata

Art. 550923981
€ 60,57 M.O.: 1



MICROFONI E RADIOMICROFONI



Microfono dinamico impugnatura in metallo con cavo da 5mt

Art. 550923331
€ 20,92 M.O.: 1



Microfono dinamico impugnatura in plastica soft grip con cavo da 4mt

Art. 550923332
€ 10,28 M.O.: 1



WM55
Sistema microfonico UHF PLUG-AND-PLAY
 con 1 microfono palmare
 863 - 865 MHz

Art. 550923344
€ 58,33 M.O.: 1



WM552
Sistema microfonico UHF PLUG-AND-PLAY
 con 2 microfoni palmari
 863 - 865 MHz

Art. 550923343
€ 108,58 M.O.: 1

WM522
Set microfonico VHF
a 2 canali

con 2 microfoni palmari
200.175 MHz
201.400 MHz



Art. 550923350
€ 120,83 M.O.: 1

WM522B
Set microfonico VHF
con 2 Bodypack

In dotazione: clip + Archetto

200.175 MHz
201.400 MHz



Art. 550923351
€ 154,17 M.O.: 1

Sistema microfonico
VHF ST WM712

Con 2 microfoni palmari
200.175 MHz
201.400 MHz



Art. 550923834
€ 106,34 M.O.: 1

WM82
Set microfonico UHF
a frequenza fissa

2 canali, 2 microfoni palmari,
display blu, 2x uscite XLR e
1 uscita Jack da 6,3mm
Custodia in plastica

863.100 MHz
864.500 MHz



Art. 550923770
€ 177,25 M.O.: 1

WB82B
Set microfonico UHF
a frequenza fissa

2 canali, 2 bodypack
cuffie e microfoni a clip
display blu, 2x uscite
XLR, 1 uscita Jack da 6,3mm
Custodia in plastica

863.100 MHz
864.500 MHz



Art. 550923771
€ 183,42 M.O.: 1

WM82C
Set microfonico UHF
a frequenza fissa

2 canali, 2 microfoni:
1 palmare e 1 bodypack con cuffia
e microfono a clip, display blu
2x uscite XLR e 1 uscita Jack da 6,3mm
Custodia in plastica

Mic 863.100 MHz
Bodypack 864.500 MHz



Art. 550923772
€ 180,84 M.O.: 1

PD504H
Set Microfonico
via Radio

4 x 50 ch, banda UHF
con 4 microfoni
ad impugnatura



Art. 550923773
€ 564,68 M.O.: 1

PD504B
Set Microfonico
via Radio

4 x 50 ch, banda UHF
con 4 Bodypack
inclusi microfoni Lavalier
e ad archetto



Art. 550923774
€ 674,34 M.O.: 1



TELEFONIA

Gigaset



Telefono cordless
Gigaset PURE 100

ARTICOLO	MODELLO	M.O.	PREZZO €
531812136	PURE 100 Nero	1	38,54
531812137	PURE 100 Bianco	1	38,54



Telefono cordless Gigaset DECT
con tasti grandi E270

ARTICOLO	MODELLO	M.O.	PREZZO €
531812121	E270 - Nero	1	69,92
531812122	E270 - Bianco	1	69,92
531812123	E270 Duo - Nero	1	104,96



Telefono cordless Gigaset A170

ARTICOLO	MODELLO	M.O.	PREZZO €
531812111	A170 Nero	1	38,54
531812113	A170 Duo Nero	1	73,33



Telefono cordless
con vivavoce Gigaset A270

ARTICOLO	MODELLO	M.O.	PREZZO €
531812115	A-270 Nero	1	48,92
531812116	A-270 Bianco	1	48,92



Telefono cordless
con vivavoce GIGASET AS 490

ARTICOLO	MODELLO	M.O.	PREZZO €
531812124	AS 490 bianco	1	61,17
531812125	AS 490 nero	1	61,17



Telefono cordless
AS 490 AM con segreteria

Art. 531812126
€ 78,69 M.O.: 1



Telefoni cordless base colorata Panasonic

ARTICOLO	MODELLO	RICEV	COLORE	M.O.	PREZZO €
531812095	KX-TG1612JTW	2	bianco	1	75,70
531812096	KX-TG1613JTH	3	nero	1	94,57

Panasonic



Telefoni cordless base
colorata Panasonic

ARTICOLO	MODELLO	COLORE	M.O.	PREZZO €
531812119	KX-TGB610JTB	nero	1	39,58
531812120	KX-TGB610JTW	bianco	1	39,58



Telefono Super Bravo plus

Art. 531811929
 € 128,85 M.O.: 1



Gigaset



Telefono con filo da scrivania e da parete Gigaset

ARTICOLO	MODELLO	M.O.	PREZZO €
531812127	DESK 200 WHITE	1	40,27
531812128	DESK 200 BLACK	1	40,27



Telefono con filo da scrivania e da parete Gigaset

ARTICOLO	MODELLO	M.O.	PREZZO €
531812129	DESK 400 WHITE	1	48,33
531812130	DESK 400 BLACK	1	48,33



Panasonic

Telefono a filo Panasonic

ARTICOLO	MODELLO	COLORE	M.O.	PREZZO €
531812103	KX-TS520EX1B	nero	1	34,65
531812104	KX-TS520EX1W	bianco	1	34,65



ILLUMINAZIONE: TORCE LED IN ESPOSITORE



**TORCIA LED AD ALTA LUMINOSITÀ
CON GANCIO E MAGNETE**

1 LED 3W COB + 1 LED 1W (frontale)
3 LED rossi (funzione emergenza)
150 lm / 60 lm
Batterie 3 x AAA (non include)

Espositore
da banco
12 pz

Art. 499048787
€ 7,80 M.O.: 12



**TORCIA LED AD ALTA LUMINOSITÀ
CON GANCIO E MAGNETE**

1 LED 3W COB
150 lm
Batterie 3 x AA (non include)

Espositore
da banco
12 pz

Art. 499048788
€ 5,72 M.O.: 12



**TORCIA A LED
ALTA LUMINOSITÀ
CON MAGNETE**

1 LED 1W COB
80 lm
Batterie 3x AAA
(non include)

Espositore
da banco
12 pz

Art. 499048789
€ 5,76 M.O.: 12

**LAMPADA LED
DA LAVORO TASCABILE
CON GANCIO E MAGNETE**

1 LED 2W COB
90 lm
Batterie 3x AAA
(non include)

Espositore
da banco
12 pz



Art. 499048790
€ 5,76 M.O.: 12

**TORCIA LED A PENNA
AD ALTA LUMINOSITÀ**

1 LED 1W COB
100 lm
clip rotante
Batterie 3x AAA
(non include)

Espositore
da banco
12 pz



Art. 499048791
€ 4,34 M.O.: 12



**LENTE LED
INGRANDIMENTO 3X**

12 LED SMD
75 lm
Batterie 3x AA
(non include)

Espositore
da banco
12 pz

Art. 499048792
€ 6,23 M.O.: 12

ILLUMINAZIONE: LAMPADE DA LAVORO



MKC-140A
Lampada a pantografo
56 LED con lente 5 diottrie
con morsetto a vite

Art. 499902616
€ 97,60 M.O.: 1



MKC-137
Lampada
da lavoro 15 LED
con lente 3 + 12
diottrie da tavolo

Art. 499902618
€ 44,53 M.O.: 1

ILLUMINAZIONE: LAMPADE DA ESTERNO

GARDEN BALL

Lampade sferiche da giardino

Lampada da giardino sferica, disponibile in tre misure
resistente a temperatura ed umidità
Materiale: polietilene ad alta resistenza
Colore Grigio
Attacco lampadina: E27
Indice di protezione IP65
Lunghezza cavo 2mt



ARTICOLO	MODELLO	DMENSIONI	M.O.	PREZZO €
499048793	GARDEN BALL S	250 x 230 mm	1	75,11
499048794	GARDEN BALL M	280 x 250 mm	1	98,72
499048795	GARDEN BALL L	380 x 350	1	122,31

MIMOSA

Strip portalampada da esterno con attacco E27

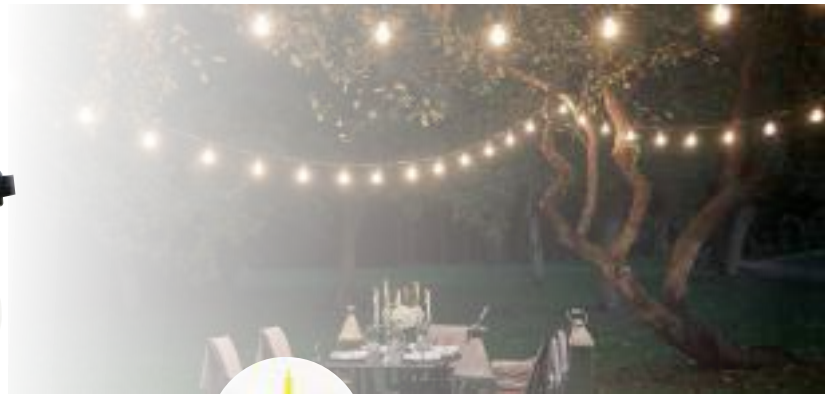

ARTICOLO	LUNGHEZZA TOTALE	N° PORTA LAMPADA	DISTANZA PUNTI LUCE	M.O.	PREZZO €
499053020	10 mt	10	1 mt	1	52,46
499053021	10 mt	20	0,5 mt	1	70,05
499053022	20 mt	20	1 mt	1	93,23



Lampadina filamento LED E27 1.3W 90lm 3000K

Ideale per Strip MIMOSA

Art. 499053023
€ 2,75 M.O.: 100

LAMPADA FREEDOM

Temperatura colore selezionabile su 3 livelli
Regolazione intensità luminosa
Regolazione continua del colore (solo per versione RGB)
Base e stelo in metallo
Lunga durata della batteria
Dimmerabile: Sì
Grado di Protezione: IP44
Colore case: bianco
Dimensioni (LxWxH): 130 x 130 x 380mm



CODICE	TIPO LED	POTENZA	LUMEN	TEMPERATURA COLORE	ALIMENT.	TIPO BATTERIA	DURATA BATTERIA
499048759	2835	4 W	200 Lm	TUNABLE WHITE (3000K - 4000K - 5000K)	5V - USB-C	2x1800 Mah Litio	6H
499048760				RGB + TUNABLE WHITE (3000K - 4000K - 5000K)			

Art. 499048759
€ 40,78 M.O.: 1

Art. 499048760
€ 49,36 M.O.: 1

Bianco dinamico + RGB
499048760

Bianco dinamico
499048759



ILLUMINAZIONE: LAMPADINE AD INTERVENTO AUTOMATICO



MG-3327L Lampada a intervento automatico 18 LED

Alimentazione: 230V
Batteria ricaricabile al piombo: 4V 5,5A
Tempo di carica: 15-20 ore
Durata: 10 ore

Art. 499902718

€ 19,11 M.O.: 1



604W Lampada a intervento automatico slim 60 LED

Potenza 4W
Batteria ricaricabile al litio

Art. 499902724

€ 18,24 M.O.: 1

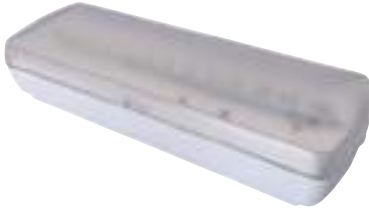

Lampada LED d'emergenza a parete 6W 300Lm

Alimentazione: 220-240 V
Litio: 3,7 V 2000 Mah
Sorgente luminosa: 12 LED SMD 2835
Potenza: 6 W
Lumen: 300 Lm

Tempo di ricarica: 15-24h
Autonomia: >2 ore
Tempo di attivazione: <0,2 sec
Protezione IP: IP20
Dimensioni (mm): 255 x 90 x 50

Art. 499902725

€ 31,87 M.O.: 1

STAZIONI BAROMETRICHE

techno
LINE



WS 6449 Stazione Meteo
Design a colori radiocontrollata con sensore esterno

Art. 262152158

€ 109,02 M.O.: 1



WS 6462 Stazione Meteo
Design a colori radiocontrollata (radio sveglia) con sensore esterno

Art. 262152129

€ 105,96 M.O.: 1



WS 6762 Stazione Meteo
Radiocontrollata con sensore esterno

Art. 262152154

€ 61,29 M.O.: 1



WS 6447 Stazione Meteo
Design a colori radiocontrollata con sensore esterno

Art. 262152156

€ 77,54 M.O.: 1



WS 9114 Stazione Meteo
in bianco e nero per interni o esterni con sensore esterno

Art. 262152153

€ 28,04 M.O.: 1



WS 1010 Termometro Digitale per la casa

Art. 262152152

€ 17,33 M.O.: 1



WS 9440 Termo Igrometro con supporto magnetico

Art. 262152148

€ 18,77 M.O.: 1

FUSIBILI

ARTICOLO	MPN	DIMENSIONI	CORRENTE	TIPOLOGIA	MATERIALE	M.O.	PREZZO €
810360695	CF520150	5 x 20 mm	500 mA	RAPIDO	VETRO	10	0,27
810360705	CF520180		800 mA			10	0,27
810360710	CF520210		1 A			10	0,27
810360715	CF520212		1,25 A			10	0,27
810360720	CF520216		1,6 A			10	0,27
810360725	CF520220		2 A			10	0,27
810360730	CF520225		2,5 A			10	0,27
810360735	CF520231		3,15 A			10	0,27
810360740	CF520240		4 A			10	0,27
810360745	CF520250		5 A			10	0,27
810360750	CF520263		6,3 A			10	0,27
810360755	CF520280		8 A			10	0,30
810360760	CF520310		10A			10	0,30
810360775	CF520320		20 A			10	0,46
810360945	GF520150		500 mA			CERAMICA / QUARZO	10
810360990	GF520263	6,3 A	10	0,75			
810360795	CF632216	6,3 x 32 mm	1,6 A	VETRO	10	0,61	
810360815	CF632240		4 A		10	0,61	
810360830	CF632280		8 A		10	0,73	
810360835	CF632310		10 A		10	0,73	
810360845	CF632316		16 A		10	0,84	
810360850	CF632320		20 A	10	0,95		
810365120	GF632220		2 A	CERAMICA / QUARZO	10	1,08	
810365135	GF632250		5 A		10	1,08	
810365150	GF632310		10 A		10	1,08	
810365165	GF632320		20 A		10	1,31	
810360865	CT632180	14 x 51 mm	800 mA	RITARDATI	VETRO	10	1,39
810360905	CT632250		5 A			10	0,84
810360930	CT632316		16 A			10	1,20
810360935	CT632320		20 A			10	1,20
810365920	GI138310	14 x 51 mm	10 A	RAPIDO	CERAMICA	10	1,52
810365835	AM138310		10 A			10	1,68
810365845	AM138316		16 A			10	1,89
810365855	AM138325		25 A			10	2,17
810365955	GI151320		20 A	ACCOMPAGNAMENTO MOTORE		10	2,46
810365965	GI151332		32 A			10	2,83
810365870	AM151432		32 A			10	2,96
810365880	AM151450		50 A			10	3,13

PORTAFUSIBILI E MINI FUSIBILI AUTO

V1162
 Portafusibile auto mini a lama
Art. 810360630
€ 4,69 M.O.: 10



PORTAFUSIBILI



C1010
Art. 810365690
€ 0,39 M.O.: 50

Portafusibile C1010 6A 250V



V1068
Art. 10365750
€ 2,96 M.O.: 25

Portafusibile V1068 10A 250V



M1015
Art. 810365730
€ 1,96 M.O.: 10

Portafusibile M1015 15A 250V



CP5518
Art. 810365760
€ 0,45 M.O.: 50

Coperchio in gomma trasparente autoestinguente per fusibili 5X20



K1010
Art. 810365720
€ 3,21 M.O.: 1

Portafusibile K1010 = FH-B02



CE5518/N
Art. 810365705
€ 0,25 M.O.: 50

Cappuccio CE5518/N nero

SPINE E PRESE TRIPOLARI



PX6010028
Art. 492518260
€ 7,77 M.O.: 1

Spina rete tripolare da pannello con portafusibile alta qualità



PX5800028
Art. 492518257
€ 3,04 M.O.: 1

Spina rete tripolare da pannello alta qualità



PX5870000
Art. 492518271
€ 8,17 M.O.: 1

Presina rete tripolare volante PX587

INTERRUTTORI



I3913
Art. 810360120
€ 4,46 M.O.: 1

Interruttore luminoso I3913=ROSSO



I3915
Art. 810360125
€ 5,69 M.O.: 1

Interruttore luminoso I3915=VERDE



I4613
Art. 810360130
€ 2,85 M.O.: 1

Interruttore luminoso I4613=ROSSO



I4615
Art. 810360135
€ 3,65 M.O.: 1

Interruttore luminoso I4615=VERDE



I4713
Art. 810360145
€ 4,44 M.O.: 1

Interruttore luminoso I4713=ROSSO



I4715
Art. 810360150
€ 4,88 M.O.: 1

Interruttore luminoso I4715=VERDE



KB06648A0BB
Art. 810360160
€ 2,33 M.O.: 1

Interruttore unipolare NERO ON - OFF



KB06648B2BG
Art. 810360165
€ 3,92 M.O.: 1

Interruttore unipolare luminoso VERDE ON - OFF



KB11248A0BB
Art. 810360175
€ 3,98 M.O.: 1

Interruttore unipolare NERO ON - OFF



KB11248B2BG
Art. 810360180
€ 4,83 M.O.: 1

Interruttore unipolare luminoso VERDE ON - OFF



KB24448A0BB
Art. 810360190
€ 4,98 M.O.: 1

Interruttore bipolare NERO ON - OFF



KB24448B2BG
Art. 810360195
€ 6,81 M.O.: 1

Interruttore bipolare luminoso VERDE ON - OFF



I4720
Art. 810360155
€ 3,46 M.O.: 1

Interruttore I4720=NERO



KB06648B2BR
Art. 810360170
€ 4,08 M.O.: 1

Interruttore unipolare luminoso ROSSO ON - OFF



KB11248B2BR
Art. 810360185
€ 5,19 M.O.: 1

Interruttore unipolare luminoso ROSSO ON - OFF



KB24448B2BR
Art. 810360200
€ 7,46 M.O.: 1

Interruttore bipolare luminoso ROSSO ON - OFF

ELETTROMECCANICA & AUTOMAZIONE



T25A
Dissipatore termico 18 C/W
Art. 811800660
€ 1,54 M.O.: 10



ALT/134-C
Altoparlante Ø29mm
8 Ohm
Art. 811770360
€ 1,74 M.O.: 5



ALT/137-C
Altoparlante Ø70mm
8 Ohm
Art. 811770375
€ 4,38 M.O.: 5



BUZZER

ARTICOLO	MPN	TIPO	M.O.	PREZZO €
811795780	RO/85/12-C	Elettronico 12V	10	4,33
811795785	RO/85/24-C	Elettronico 24V	10	4,33
811795790	RO/85/6-C	Elettronico 6V	10	4,33
812120295	RO/86-C	Piezo Oscill. Interruttore 18Ma	10	5,00
812120305	RO/87-C	Piezo. 2Ma	10	4,17



CAPSULA MICROFONICA A CONDENSATORE

ARTICOLO	MPN	DIM. / TIPO	M.O.	PREZZO €
811775290	B/1765-C	Ø 9,8 H7mm	10	2,48
811775295	B/1768-C	Ø 9,8x7mm con fili	10	2,54
811810120	B/1765-I	Ø 9,8 H7mm	100	1,05
811810125	B/1768-I	Ø 9,8x7mm con fili	100	1,51



SIRENA

ARTICOLO	MPN	TIPO	M.O.	PREZZO €
811800285	SI/277-C	Elettr. 112Db 12V 82x92x77	1	19,87
811825275	SI/277-I	Elettr. 112Db 12V 82x92x77	10	13,27
811800300	SI/300-C	Piezo 12V 43x33 Passo 33	1	19,69



MINISIRENA PIEZO

ARTICOLO	MPN	TIPO	M.O.	PREZZO €
811825280	SI/280-I	12V 43x43x59mm	10	10,79
811800290	SI/280-C	12V 43x43x59mm	1	20,42



PORTALED

ARTICOLO	MPN	TIPO	M.O.	PREZZO €
811765880	GHP/16	"ABS" a pressione conico Ø5mm	10	0,69
811780915	GHP/15-C	"ABS" a pressione Ø3mm	200	0,83
811780920	GHP/17-C	"ABS" a pressione concavo Ø5mm	10	0,69
811815650	GHP/17-I	"ABS" a pressione concavo Ø5mm	100	0,26
811780815	GH/445	metallico concavo Ø3mm	10	1,33
811780835	GH/449-C	metallico concavo Ø5mm	10	1,70
811780840	GH/450-C	metallico conico Ø5mm	10	1,70
812110870	AP/SE-GN/80B-C	metallico cromato Ø 10 24V a LED	10	8,02
812110875	AP/SE-GN/80G-C	metallico cromato Ø 10 24V a LED	10	8,02
812110880	AP/SE-GN/80R-C	metallico cromato Ø 10 24V a LED	10	8,02
812110885	AP/SE-GN/80W-C	metallico cromato Ø 10 24V a LED	10	8,02
812110890	AP/SE-GN/80Y-C	metallico cromato Ø 10 24V a LED	10	8,02



PORTAPILE e ATTACCO PER PORTAPILE

ARTICOLO	MPN	TIPO	M.O.	PREZZO €
812210610	PIL/33-C	chiuso x 2 stilo con fili e int. On/Off	2	1,88
812210625	PIL/36-C	chiuso x 3 ministilo con fili e int. On/Off	2	1,54
812210630	PIL/37-C	chiuso x 4 ministilo con fili e int. On/Off	2	1,95
812210645	PIL/44-C	per 3 stilo con fili	2	0,85
812210650	PIL/45-C	per 4 torce con fili	2	2,25
812210675	PIL/66-C	2 stilo Ø 14x50 con fili	2	0,64
812210680	PIL/66A-C	2 stilo Ø 14x50 con bottone	2	0,64
812210700	PIL/72-C	4 stilo Ø 14x50 con fili	2	1,10
812210705	PIL/73-C	4 stilo Ø 14x50 con bottone	2	1,10
812210765	PIL/85-C	2 ministilo con fili	2	0,64
812210750	PIL/83-C	4 ministilo con fili	2	1,22
812210760	PIL/840-C	per pile: CR2016 CR2025 CR2032	2	0,89
812210815	ATP/65-C	attacco x portapile - pile 9V	10	0,50
812210820	ATP/66-C	attacco x portapile - pile 9V A"	10	0,50



MATERIELE ELETTRICO

BOCCOLA ISOLATA CHIUSA

ARTICOLO	MPN	COLORE	DIMENSIONE	M.O.	PREZZO €
811850955	BO/7B-C	Blu	4 mm	10	1,19
811850960	BO/7G-C	Giallo	4 mm	10	1,19
811850965	BO/7N-C	Nero	4 mm	10	1,19



ARTICOLO	MPN	COLORE	DIMENSIONE	M.O.	PREZZO €
811850970	BO/7R-C	Rosso	4 mm	10	1,19
811850975	BO/7V-C	Verde	4 mm	10	1,19

COCCODRILLO ISOLATA

ARTICOLO	MPN	TIPO	M.O.	PREZZO €
811855435	COC/61N-C	37 mm Nero	10	0,18
811855440	COC/61R-C	37 mm Rosso	10	0,18
811855445	COC/62N-C	43 mm Nero	10	0,23
811855450	COC/62R-C	43 mm Rosso	10	0,23
811855455	COC/63N-C	62 mm Nero	10	0,32
811855460	COC/63R-C	62 mm Rosso	10	0,32



COCCODRILLO ISOLATA

ARTICOLO	MPN	TIPO	M.O.	PREZZO €
811855520	COC/AK/2N	80,5 mm con foro Nero	1	9,40
811855525	COC/AK/2R	80,5 mm con foro Nero	1	9,40



MAZ/60-C

Set coccodrilli 10
coppie Col. 46 cm

Art. 811870190

€ 7,63 M.O.: 5

MAZ/60A-C

Set coccodrilli 10
coppie Col. 56 cm

Art. 811870195

€ 11,62 M.O.: 5

PINZA ISOLATA

ARTICOLO	MPN	TIPO	M.O.	PREZZO €
811875915	PZ/66N-C	40A 85mm Nero	10	1,86
811875920	PZ/66R-C	40A 85mm Rossa	10	1,86



PINZA BATTERIA PROFESSIONALE 90mm colore nero in Acciaio Zincato

Art. 811875965

€ 2,75 M.O.: 10



Scopri di più su
www.melchioni-ready.com

MATERIE ELETTRICO

PINZA FLANGIA CON GANCIO



ARTICOLO	MPN	TIPO	M.O.	PREZZO €
811875980	PZ/C30NX-C	158mm Nero	1	21,73
811875990	PZ/C30RX-C	158mm Rosso	1	21,73

PRESA DA PANNELLO SCHERMATA



ARTICOLO	MPN	TIPO	M.O.	PREZZO €
811875515	PR/850	DIN 5P a vite	5	8,53
811875525	PR/854	DIN 3 posizioni a vite	5	8,53
811875775	PRE/860	2P a vite	5	7,08

SPINA VOLANTE



ARTICOLO	MPN	TIPO	M.O.	€
811880890	SP/365NX-C	dorata coassiale RCA schermata n. con guidacavo nera	5	6,69
811880895	SP/365RX-C	dorata coassiale RCA schermata con guidacavo rossa	5	6,69
811880900	SP/366N-C	coassiale RCA nera Id 6.5	5	11,07
811880905	SP/366R-C	coassiale RCA rosso Id 6.5	5	11,07
811885340	SP/851	schermata DIN 5 posizioni a vite	5	7,91
811885350	SP/855	schermata DIN 3 posizioni a vite	5	7,52
811885360	SP/861	schermata 2 posizioni a vite	5	8,48

SPINA BANANA



ARTICOLO	MPN	TIPO	M.O.	PREZZO €
812160205	BAPRO/433GBX-C	Ø4mm Dorata Blu	10	2,06
812160210	BAPRO/433GGX-C	Ø4mm Dorata Giallo	10	2,06
812160215	BAPRO/433GNX-C	Ø4mm Dorata Nero	10	2,06
812160220	BAPRO/433GRX-C	Ø4mm Dorata Rossa	10	2,06
812160225	BAPRO/433GVX-C	Ø4mm Dorata Verde	10	2,06
811850635	BA/433/HN	Professionale Bula 20K Nero	10	4,19
811850640	BA/433/HR	Professionale Bula 20K Rossa	10	4,19
812160230	BAPRO/433GX-C	Prof. Ø4mm Foro Lat. Giallo	10	1,77
812160235	BAPRO/433NX-C	Prof. Ø4mm Foro Lat. Nero	10	1,77
812160240	BAPRO/433RX-C	Prof. Ø4mm Foro Lat. Rosso	10	1,77
812160245	BAPRO/433VX-C	Prof. Ø4mm Foro Lat. Verde	10	1,77



PUNT/65-C

Kit puntali universale per tester

Art. 811875905

€ 16,94 M.O.: 2



PUNT/66-C

Coppia puntali isolati rosso/nero

Art. 811875910

€ 13,29 M.O.: 2

CONNETTORI TERMINALI A SALDARE

CALOTTE



ARTICOLO	MPN	TIPO	M.O.	PREZZO €
811855220	C/2300X-C	Calotta gr. anc. lunghi 9 poli	10	1,10
811855225	C/2301X-C	Calotta gr. anc. lunghi 15 poli	10	1,10
811855240	C/2302X-C	Calotta gr. anc. lunghi 25 poli	10	1,54

CALOTTE



ARTICOLO	MPN	TIPO	M.O.	PREZZO €
811855300	C/950EX-C	Calotta 9 poli grigio	10	0,60
811855320	C/951EX-C	Calotta 15 poli grigio	10	0,60
811855335	C/952EX-C	Calotta 25 poli grigio	10	0,96

CONNETTORE FEMMINA



ARTICOLO	MPN	TIPO	M.O.	PREZZO €
811955215	CT/2020-I	Ins. Dir. 10P.	100	0,12
811860580	CT/2020-C	Ins. Dir. 10P.	10	0,23
811860585	CT/2021-C	Ins. Dir. 14P.	10	0,28
811860595	CT/2023-C	Ins. Dir. 20P.	10	0,34

CONNETTORE A PETTINE



ARTICOLO	MPN	TIPO	M.O.	PREZZO €
811860730	CT/40-C	Str. M. 40P 2,54 Dorato H.6	100	0,41
811860740	CT/40/90A-C	Str. M. 40P 90° 2,54 Dorato	10	0,69
811860785	CT/80-C	Str. Doppia P. 2,54 80P	100	0,92
811860925	CTF/40-C	Femmina 40P 2,54 Div.	10	5,82



CONNETTORI TERMINALI A SALDARE



CONNETTORE A VASCHETTA

ARTICOLO	MPN	TIPO	M.O.	PREZZO €
811865315	F/910-C	a saldare 9P femmina	20	0,64
811865320	F/910/90-C	9P femmina 90°	20	0,87
811865350	F/911-C	a saldare 15P femmina	20	0,87
811865355	F/911/90-C	15P femmina 90°	20	1,10
811865360	F/911/AD-C	15P femmina alta definizione	20	0,64

ARTICOLO	MPN	TIPO	M.O.	PREZZO €
11865905	M/900-C	a saldare 9P maschio	20	2,34
11865910	M/900/90-C	9P maschio 90°	20	0,87
11865940	M/901-C	a saldare 15P maschio	20	0,55
11865945	M/901/90-C	15P maschio 90°	20	1,01
11865950	M/901/AD-C	15P maschio alta definizione	20	0,60



CONNETTORE DA CIRCUITO STAMPATO

ARTICOLO	MPN	TIPO	M.O.	PREZZO €
811860930	CTF/40A-C	Striscia Femmina Vert 2,54 40P	10	1,33
811860485	CT/2010-C	Maschio Ins. Dir. 10P	10	0,23
811860495	CT/2011-C	Maschio Ins. Dir. 14P	10	0,30
811860515	CT/2013-C	Maschio Ins. Dir. 20P	10	0,39



ZOCOLO TULIPANO DA CIRCUITO STAMPATO

ARTICOLO	MPN	TIPO	M.O.	PREZZO €
11890295	ZT/8-C	8 Poli	10	0,60
11890255	ZT/14-C	14 Poli	10	1,05
11765910	ZT/20-C	20 Poli	10	1,54
11890290	ZT/40-C	40 Poli	10	3,05

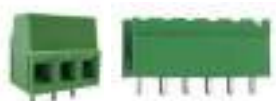

MORSETTO DA CIRCUITO STAMPATO

ARTICOLO	MPN	TIPO	M.O.	PREZZO €
811855805	COMP/2B-C	componibile 2 Poli P.5mm con carrello	1	1,15
811860210	COMP/3B-C	componibile 3 Poli P.5mm con carrello	1	1,72
811870245	MO/25002V-C	diritto aperto 2 posizioni P5mm 12A	100	0,21
811870255	MO/25003/C-C	diritto chiuso 3 posizioni P5mm 12A	100	0,25
811870265	MO/25003V-C	diritto aperto 3 posizioni P5mm 12A	100	0,32
811870275	MO/25004/C-C	diritto chiuso 4 posizioni P5mm 12A	100	0,41
811870285	MO/25004V-C	diritto aperto 4 posizioni P5mm 12A	100	0,41
811870295	MO/25005/C-C	diritto chiuso 5P P5mm 12A	100	0,53
811870305	MO/25005V-C	diritto aperto 5P P5mm 12A	100	0,53

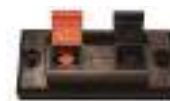

MORSETTIERA

ARTICOLO	MPN	TIPO	M.O.	PREZZO €
811870215	MO/2-C	da pannello 2P.	10	1,81
811870220	MO/250012/10-C	passo 10 2 Poli	100	0,23
811870225	MO/25002-C	passo 5 2 Poli	100	0,60
811870235	MO/25002/C-C	2 poli P.5	100	0,18
811870250	MO/25003-C	3 poli P.5	100	0,92
811870270	MO/25004-C	4 poli P.5	100	1,22
811870290	MO/25005-C	5 poli P.5	100	1,86
811870310	MO/25006-C	6 poli P.5	100	1,81
811870330	MO/2502-C	2 poli P.5.08	100	0,73
811870335	MO/2503-C	3 poli P.5.08	100	1,47
811870340	MO/2504-C	4 poli P.5.08	100	1,60
811870345	MO/2505-C	5 poli P.5.08	100	2,15



MORSETTO SERRAFILO ISOLATA

ARTICOLO	MPN	TIPO / COLORE	M.O.	PREZZO €
811880480	SER/430B	15A Blu	10	2,59
811880485	SER/430G	15A Giallo	10	2,59
811880495	SER/430N	15A Nero	10	2,59

ARTICOLO	MPN	TIPO / COLORE	M.O.	PREZZO €
811880500	SER/430R	15A Rosso	10	2,59
811880505	SER/430V	15A Verde	10	2,59

CONTENITORI PROTETTIVI

CONTENITORE TERMOPLASTICO

ARTICOLO	MPN	DIMENSIONE / TIPO	M.O.	PREZZO €
811795935	SC/700-C	56 x 90 x 23	10	1,19
811795940	SC/701-C	60 x 130 x 29	10	2,61
811795945	SC/703	40 x 73 x 20	10	1,47
811795950	SC/704-C	35 x 58 x 16	10	1,28
811795955	SC/705-C	56 x 120 x 31	10	2,75



ARTICOLO	MPN	DIMENSIONE / TIPO	M.O.	PREZZO €
811795960	SC/706-C	56 x 120 x 31 con griglia	10	2,84
811795965	SC/707-C	39 x 78 x 22	10	1,28
811795970	SC/708-C	60 x 99 x 30 con finestra	5	1,42

ADESIVI E FISSAGGIO



IS/TO220-C

Isolatore in plastica per To-220

Art. 811785420

€ 0,16 M.O.: 100



DISTANZIALI IN OTTONE NICHELATO

ARTICOLO	MPN	TIPO / COLORE	M.O.	PREZZO €
811840115	DF/15-C	F+F Chiave 5 3Ma 15mm	100	0,25
811840140	DF/20-C	F+F Chiave 5 3Ma 20mm	100	0,37
811840160	DF/25-C	F+F Chiave 5 3Ma 25mm	100	0,46
811840175	DF/30-C	F+F Chiave 5 3Ma 30mm	100	0,53
811840200	DF/5-C	F+F Chiave 5 3Ma 5mm	100	0,16
811840220	DF/7-C	F+F Chiave 5 3Ma 7mm	100	0,18
811840235	DF4/10-C	F+F Chiave 6 4Ma 10mm	100	0,28
811840245	DF4/15-C	F+F Chiave 6 4Ma 15mm	100	0,39
811840265	DF4/20-C	F+F Chiave 6 4Ma 20mm	100	0,46

ARTICOLO	MPN	TIPO / COLORE	M.O.	PREZZO €
811840295	DF4/5-C	F+F Chiave 6 4Ma 5mm	100	0,16
811840445	DM/10-C	M+F Chiave 5 3Ma 10mm	100	0,25
811840470	DM/15-C	M+F Chiave 5 3Ma 15mm	100	0,34
811840490	DM/20-C	M+F Chiave 5 3Ma 20mm	100	0,46
811840510	DM/25-C	M+F Chiave 5 3Ma 25mm	100	0,53
811840525	DM/30-C	M+F Chiave 5 3Ma 30mm	100	0,46
811840560	DM/5-C	M+F Chiave 5 3Ma 5mm	100	0,23
811840575	DM/60-C	M+F Chiave 5 3Ma 60mm	100	1,15
811840585	DM/7-C	M+F Chiave 5 3Ma 7mm	100	0,25
811840600	DM4/10-C	M+F Chiave 6 4Ma 10mm	100	0,37
811840615	DM4/15-C	M+F Chiave 6 4Ma 15mm	100	0,46
811840635	DM4/20-C	M+F Chiave 6 4Ma 20mm	100	0,53
811840670	DM4/5-C	M+F Chiave 6 4Ma 5mm	100	0,30

FUSIBILI E PORTAFUSIBILI



PORTAFUSIBILI

ARTICOLO	MPN	TIPO	M.O.	PREZZO €
811795385	PTF/600-C	Portafusibili A Pannello 5x20 10A-250V	10	1,33
811795445	PTFP/108-C	Portafusibili A Pannello 6,3x32 10A-250V	10	2,09
811795455	PTFV/215-C	Portafusibile Volante 6,3x32	10	1,74
811795460	PTFV/220-C	Portafusibile Volante x Fusibile 5x20	10	0,80
811795395	PTF/602-C	Portafusibili Circuito Stampato 5x20 6A-250V	10	0,64
812120185	PTF/606	Portafusibili Circuito Stampato 5x20 Con Nor. 6,3A-250V Verdi	10	0,34
812120190	PTF/606N	Portafusibili Circuito Stampato 5x20 Con Nor. 6,3A-250V Nero	10	0,34



PRO/609-C

Protezione per portafusibili Ptf/606 Verde

Art. 811795265

€ 0,21 M.O.: 100



PRO/609N-C

Protezione per portafusibili Ptf/606 Nero

Art. 811795270

€ 0,32 M.O.: 100



INTERRUTTORI-PULSANTI E DEVIATORI

PULSANTE



ARTICOLO	MPN	TIPO	M.O.	PREZZO €
811770685	AP/INT/542-C	d'emergenza a rilascio rosso	1	11,05
811770825	AP/INT/B542-C	d'emergenza a rilascio ø4	1	10,22
811770835	AP/INT/B642-C	d'emergenza a rilascio ø6	1	11,16
811770850	AP/INT/C21-C	a rilascio nero ø40 con test	1	9,26



INTERRUTTORE A BILANCIERE

ARTICOLO	MPN	TIPO	M.O.	PREZZO €
811785195	INT/2280H-C	16A-250V Bipolare Rosso	10	2,61
811785205	INT/2281H-C	16A-250V Bipolare Verde	10	3,07
811785215	INT/2282H-C	16A-250V Bipolare Nero	10	1,90
811785330	INT/3403H-C	10A-250V Bipolare Verde	10	2,50
811785335	INT/3404H-C	10A-250V Bipolare Blu	10	1,60
811785340	INT/3405H-C	10A-250V Bipolare All Nero	10	1,86
811785360	INT/3434H-C	Rotondo 10A 250V Verde Ma	10	1,74
811765565	INT/3433H-C	Rotondo 10A 250V Rosso Mark	10	1,44
811765570	INT/3435H-C	Rotondo 10A 250V Mark 0-1 Nero	10	1,51



INTERRUTTORE PARAPOLVERE E A CHIAVE

ARTICOLO	MPN	TIPO	M.O.	PREZZO €
811785250	INT/291G-C	Luminoso 12V Parapolvere	10	7,13
811785255	INT/291R-C	Luminoso 12V Parapolvere	10	7,13
811785260	INT/291Y-C	Luminoso 12V Parapolvere	10	7,13
812110945	B/1008-C	A Chiave 1A 250V	5	12,12



SELETTORE 2 POSIZIONI FISSE

ARTICOLO	MPN	TIPO	M.O.	PREZZO €
811770535	AP/INT/2365-C	luminoso LED leva verde	1	20,67
811770545	AP/INT/2465-C	luminoso LED leva rosso	1	23,99
811770855	AP/INT/D21-C	a leva nero	1	9,83

DEVIATORE A BILANCIERE



ARTICOLO	MPN	TIPO	M.O.	PREZZO €
811775520	DE/2288H-C	bipolare tasto N. posizioni On-On Nero	10	2,93
811775530	DE/2289H-C	bipolare tasto N. On-Off-On Nero	10	2,29
811775545	DE/3436H-C	Rot 10A 250V Nero M.I-0-li	10	1,40



DEVIATORE

ARTICOLO	MPN	TIPO	M.O.	PREZZO €
811775335	COM/D-C	unipolare 2 posizioni circuito stampato	20	1,42
811775415	DE/147-C	bipolare On-On 6A-125V	10	7,75



INTERRUTTORE

ARTICOLO	MPN	TIPO	M.O.	PREZZO €
811780985	INT/1800	Unipolare On-Off 16A 250V	10	7,98
812115890	INT/191-C	Unipolare On-Off 20A 125VaC 15A 25	10	4,29
812115895	INT/195-C	Bipolare On-Off 20A 125VaC 15A 250	10	6,05



PROTEZIONE PER INTERRUTTORE LUMINOSO

ARTICOLO	MPN	DIMENSIONE	M.O.	PREZZO €
811795235	PRO/2227H-C	21 x 15mm	10	0,34
811795255	PRO/3433H-C	ø 23	10	0,60



PULSANTE

ARTICOLO	MPN	TIPO	M.O.	PREZZO €
811790715	NAP/46N-C	N.A. sald. 25V nero push On	10	2,48
811790765	NAP/57N-C	N.A. sald. 3A-125V nero	10	4,26
811790770	NAP/57R-C	N.A. sald. 3A-125V rosso	10	4,26
811820425	P/2801-I	piatto metalic anti-vanda	10	5,57
811790890	P/2801-C	piatto metalic anti-vanda	1	9,51
811795140	P/LAS1AG-QB-C	piatto antivand con ring luminoso blu	1	44,44
811795145	P/LAS1AG-QR-C	piatto antivand con ring luminoso rosso	1	44,44
811795150	P/LAS1AG-QV-C	piatto antivand con ring luminoso verde	1	44,44

INTERRUTTORI-PULSANTI E DEVIATORI

MICRODEVIATORE M. CIRCUITO STAMPATO



ARTICOLO	MPN	TIPO	M.O.	PREZZO €
811790565	MS/638-C	con norm. pulsante	20	1,12
811790570	MS/639-C	con norm. leva	20	1,33
811790575	MS/640-C	con norm. leva	20	1,72

MICRODEVIATORE M.



ARTICOLO	MPN	TIPO	M.O.	PREZZO €
811790580	MS/640A-C	sald. con norm. leva	20	1,70
811790605	MS/643-C	circuito stampato con norm. leva	20	2,09
811790610	MS/643A-C	sald. con norm. leva	20	2,06

MICRODEVIATORE FASTON 4,8



ARTICOLO	MPN	TIPO	M.O.	PREZZO €
811790615	MS/644-C	con norm. leva	20	3,78
811790620	MS/645-C	con norm. leva	20	4,22
811790625	MS/646-C	con norm. puls	20	3,74

MICROPULSANTE DA CIRCUITO STAMPATO



ARTICOLO	MPN	TIPO	M.O.	PREZZO €
812115975	P/57-C	50Ma-12V P/57-C	100	0,16
812115985	P/59-C	50Ma-12V P/59-C	100	0,18

POTENZIOMETRI

MANOPOLE NERE A BUSSOLA



ARTICOLO	MPN	DIMENSIONE / COLORE	M.O.	PREZZO €
811785455	MA/1100B	15x18 Ø6 Blu	10	1,63
811785460	MA/1100G	15x18 Ø6 Gialla	10	1,63
811785470	MA/1100N	15x18 Ø6 Nera	10	1,63
811785475	MA/1100R	15x18 Ø6 Rossa	10	1,63
811785480	MA/1100V	15x18 Ø6 Verde	10	1,63

MANOPOLE NERE A BUSSOLA



ARTICOLO	MPN	DIMENSIONE / COLORE	M.O.	PREZZO €
811785515	MA/1112B	22x19 Ø6 Blu	10	1,74
811785520	MA/1112G	22x19 Ø6 Gialla	10	1,74
811785530	MA/1112N	22x19 Ø6 Nera	10	1,74
811785535	MA/1112R	22x19 Ø6 Rossa	10	1,74
811785540	MA/1112V	22x19 Ø6 Verde	10	1,74

MANOPOLE A BUSSOLA NUMERATE



ARTICOLO	MPN	DIMENSIONE / COLORE	M.O.	PREZZO €
811785575	MA/1116B	19x23 Ø6 Blu	10	1,81
811785580	MA/1116G	19x23 Ø6 Gialla	10	1,81
811785590	MA/1116N	19x23 Ø6 Nera	10	1,81
811785595	MA/1116R	19x23 Ø6 Rossa	10	1,81
811785600	MA/1116V	19x23 Ø6 Verde	10	1,81
811785755	MA/1130B	26x21 Ø6 Blu	10	2,68
811785760	MA/1130G	26x21 Ø6 Gialla	10	2,68
811785770	MA/1130N	26x21 Ø6 Nera	10	2,68
811785775	MA/1130R	26x21 Ø6 Rossa	10	2,68
811785780	MA/1130V	26x21 Ø6 Verde	10	2,68

MANOPOLE A BUSSOLA NUMERATE



ARTICOLO	MPN	DIMENSIONE / COLORE	M.O.	PREZZO €
811785875	MA/1140B	26x21 Ø6 Blu	10	2,59
811785880	MA/1140G	26x21 Ø6 Gialla	10	2,59
811785890	MA/1140N	26x21 Ø6 Nera	10	2,59
811785895	MA/1140R	26x21 Ø6 Rossa	10	2,59
811785900	MA/1140V	26x21 Ø6 Verde	10	2,59
811785815	MA/1135B	36x22 Ø6 Blu	10	3,03
811785820	MA/1135G	36x22 Ø6 Gialla	10	3,03
811785830	MA/1135N	36x22 Ø6 Nera	10	3,03
811785835	MA/1135R	36x22 Ø6 Rossa	10	3,03
811785840	MA/1135V	36x22 Ø6 Verde	10	3,09



POTENZIOMETRI



MANOPOLE A BUSSOLA NUMERATE

ARTICOLO	MPN	DIMENSIONE / COLORE	M.O.	PREZZO €
811785935	MA/1145B	36x22 Ø6 Blu	10	2,96
811785940	MA/1145G	36x22 Ø6 Gialla	10	2,96
811785950	MA/1145N	36x22 Ø6 Nera	10	2,96
811785955	MA/1145R	36x22 Ø6 Rossa	10	2,96
811785960	MA/1145V	36x22 Ø6 Verde	10	2,96



MANOPOLE IN PLASTICA

ARTICOLO	MPN	DIMENSIONE / COLORE	M.O.	PREZZO €
811790525	MA/1250	15x15 Grigio Opaco	10	3,32
811790535	MA/1252	23x13 Grigio Opaco	10	3,46
811790545	MA/1260	15x15 Nero Opaco	10	2,52
811790555	MA/1262	23x13 Nero Opaco	10	2,59

RESISTORI

POTENZIOMETRI A FILO



ARTICOLO	MPN	TIPO	M.O.	PREZZO €
811925995	PBMS100	10 Giri 100 Ohm	1	25,60
811930105	PBMS10K	10 Giri 10K	1	28,28
811930110	PBMS1K	10 Giri 1K	1	21,86

POTENZIOMETRI A STRATO DI CARBONE



ARTICOLO	MPN	TIPO	M.O.	PREZZO €
811930150	PC16/10K	a variazione lineare	1	3,78
811930155	PC16/1K	a variazione lineare	1	3,78
811930175	PC16/2K2	a variazione lineare	1	3,78
811930195	PC16/4K7	a variazione lineare	1	3,78

RELÈ

1 SCAMBIO



ARTICOLO	MPN	TIPO	M.O.	PREZZO €
811795480	RELE/1/12	1 scambio 12V	10	4,19
811795535	RELE/1/12S	1 scambio 12 V Submin.	10	3,67
811795545	RELE/1/24	1 scambio 24 V	10	3,80

2 SCAMBI



ARTICOLO	MPN	TIPO	M.O.	PREZZO €
811795630	RELE/2/12	2 scambi 12V	10	4,19
811795655	RELE/2/12S	2 scambi 12 V Submin.	10	3,55
811795680	RELE/2/24S	2 scambi 24 V Submin.	10	4,03



RELE/2100-C

Rele Reed S/Diodo 5V
N.A.1 C.

Art. 811795690

€ 8,85 M.O.: 5



RELE/2100-I

Rele Reed S/Diodo 5V
N.A.1 C.

Art. 811820860

€ 5,59 M.O.: 20

Scopri di più su
www.melchioni-ready.com



PULSANTI

MELCHIONI READY

	ARTICOLO	MODELLO	CARATTERISTICHE	COLORE	M.O.	PREZZO €
1	492619726	MS-016 SWITCH	1A - 125V	nero	1	4,33
2	492619204	DS-193 SWITCH RED	1A - 125V	rosso	1	6,30
3	492619290	DS-283 SWITCH BLACK	3A - 125V	nero	1	4,86
4	492619175	DS-466 SWITCH RED	3A - 125V	rosso	1	6,30
5	492619294	DS-282 SWITCH BLACK	3A - 125V con ritenuta	nero	1	5,99
6	492619087	MS-030 SWITCH RED	3A -250V con autoritorno	rosso	1	5,99

Pulsante unipolare n.a. off-(on)



INTERRUTTORI

	ARTICOLO	MODELLO	CARATTERISTICHE	COLORE	M.O.	PREZZO €
1	492619406	DS-060 K-S-LG SWITCH	5A - 125V	verde	1	8,25
2	433329065	R959KDFT2FS 10A 250V	15A - 220V	rosso	10	2,87
3	433329774	KNH-1	5A - 236V	-	5	2,92
4	433329321	FR5001	6A - 125V	-	5	1,26
5	433329042	-	magnetico NA+NC	-	1	15,03
6	433329045	-	magnetico NA	-	1	15,02

MELCHIONI READY



1
Interruttore a bilancere unipolare on-off

2
Interruttore a bilancere luminoso bipolare on-off

3 4
Interruttore a leva unipolare on-off

5 6
Interruttori magnetici per antifurto

DEVIATORI

	ARTICOLO	MODELLO	CARATTERISTICHE	M.O.	PREZZO €
1	492619310	MS-500 A-B SWITCH	6A - 125V ON-ON	1	5,69
2	433329323	KN3C-102A ON-ON	10A - 250V ON-OFF	5	3,19
3	433329311	FR5003	6A - 125V Unipolare ON-ON	5	1,05
4	433329315	FR5004	6A - 125V Unipolare ON-ON	5	1,61
5	433329312	FR5005	6A - 125V Unip. ON-OFF-ON	5	1,31
6	433329301	FR5017/ON-ON	6A - 125V Bipolare ON-ON	5	1,10
7	433329655	MRS-102-C1	6A - 125V ON-ON	5	0,97
8	433329793	11CL002 MINI SLIDE SWITCH	0,5A - 125V ON-ON	5	0,77

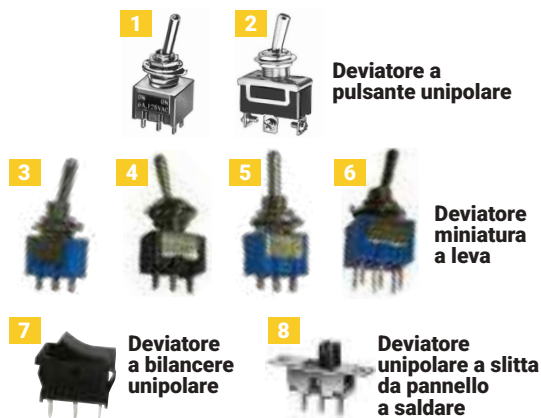

1 2
Deviatore a pulsante unipolare

3 4 5 6
Deviatore miniatura a leva

7
Deviatore a bilancere unipolare

8
Deviatore unipolare a slitta da pannello a saldare

MICRODEVIATORE

	ARTICOLO	MODELLO	CARATTERISTICHE	M.O.	PREZZO €
1	433329330	FR5704	a leva con rotella 5A - 125/250V a faston	20	2,26
2	433329331	FR5702/DC PLUG	a leva 5A - 125/250V a faston	5	1,66
3	433329332	FR5701/DC PLUG	senza leva 5A - 125/250V a faston	5	1,88
4	433329333	MSW-11 (THE BASE IS GREEN)	senza leva 5A -125V per c.s.	5	1,15
5	433329334	20CM004 MICROSWITCH	a leva 5A-125V per c.s.	5	2,15

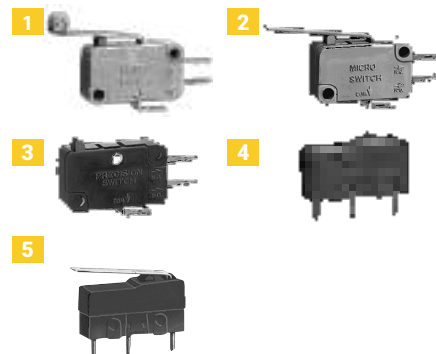

ALIMENTATORI DA BANCO

DM3005XE
Alimentatore da banco
singolo canale
0-30V 0-5A
regolabile



DM3005EIII
Alimentatore duale
da banco 0-30V 0-5A
regolabile

Art. 530136910
€ 282,65 M.O.: 1



**Alimentatori
professionali da banco
switching** voltaggio in uscita: 13.8V

Art. 530136909
€ 149,68 M.O.: 1

ARTICOLO	MODELLO	CORRENTE IN USCITA	M.O.	PREZZO €
530136911	DM1922SW	5A	1	49,64
530136912	DM1923SW	7A	1	57,14
530136913	DM1924SW	10A	1	61,03

VENTOLE



Ventola bronzina 24V

ARTICOLO	MPN	DIM. MM	M.O.	PREZZO €
811765465	VE/227	40x40x10	5	2,27



Ventola cuscinetto 24V

ARTICOLO	MPN	DIM. MM	M.O.	PREZZO €
811765470	VE/227C	40x40x10	5	5,55

Scopri l'intera gamma di ventole su
www.melchioni-ready.com



Griglie in metallo per ventola

ARTICOLO	MPN	Ø MM	M.O.	PREZZO €
811765510	GR/211	40	5	1,12
810975860	GR/209	60	2	1,12
810975865	GR/207	80	2	1,12

ARTICOLO	MPN	Ø MM	M.O.	PREZZO €
810975870	GR/210	90	2	1,17
810975875	GR/208	120	2	1,26



VENTOLE

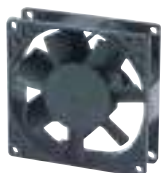

Ventola cuscinetto 230V

ARTICOLO	MPN	DIM. MM	M.O.	PREZZO €
810355765	VS1525HA2-2BMT	150x150x51	1	91,56
810355775	VS17023HA2-2BMT	172x152x38	1	110,50
810355785	VS1806HA2-2BMT	180x180x65	1	137,92



Griglie in plastica

ARTICOLO	MPN	DIM. MM	M.O.	PREZZO €
810355695	VXP08001BK	80x80	10	2,27
810355700	VXP09201BK	92x92	10	2,60
810355710	VXP12001BK	120x120	10	2,92
810355720	VXP16001BK	160x160	1	4,17
810355725	VXP17201BK	172x172	1	4,50
810355730	VXP18001BK	180x180	1	4,63



Griglie in metallo

ARTICOLO	MPN	DIM. MM	M.O.	PREZZO €
810355640	VXM02501	25x25	10	1,64
810355650	VXM04001	40x40	10	1,64
810355660	VXM06001	60x60	10	1,84
810355670	VXM09201	92x92	10	2,01
810355675	VXM12001	120x120	10	2,65
810355680	VXM15001	150x150	1	5,10



Filtro griglia metallica 3 in 1

ARTICOLO	MPN	DIM. MM	M.O.	PREZZO €
810355585	VXF04001BK	nero 40x40	1	7,48
810355590	VXF06001BK	nero 60x60	1	7,23
810355600	VXF08001BK	nero 80x80	1	6,52
810355610	VXF09201BK	nero 92x92	1	7,00
810355620	VXF12001BK	nero 120x120	1	7,31
810355625	VXF12001WH	bianco 120x120	1	7,31

CONDENSATORI DI SPUNTO

In polipropilene, senza vite, per impiego in corrente alternata, utilizzo per marcia e avviamento motori

ARTICOLO	CAPACITÀ µF	TERMINALE	DIMENSIONI (mm)	M.O.	PREZZO €
493224540	2	faston 6,3mm	30*60 mm	10	2,06
493224541	2,5	faston 6,3mm	30*60 mm	10	2,14
493224542	4	faston 6,3mm	30*60 mm	10	2,28
493224543	6,3	faston 6,3mm	32*60 mm	10	3,00
493224544	8	faston 6,3mm	34*60 mm	10	3,08
493224545	10	faston 6,3mm	34*68 mm	10	3,28
493224546	12	con cavetto	34*68 mm	10	3,26
493224547	12	faston	34*68 mm	10	4,16
493224548	14	faston 6,3mm	38*70 mm	10	3,41
493224549	16	faston 6,3mm	38*70 mm	10	3,96
493224550	20	faston 6,3mm	38*70 mm	10	5,25
493224551	25	faston 6,3mm	38*70 mm	10	6,15
493224552	30	faston 6,3mm	42*80 mm	10	7,09
493224553	35	faston 6,3mm	42*80 mm	10	7,53
493224554	40	faston 6,3mm	45*90 mm	10	8,01
493224555	50	faston 6,3mm	50*100 mm	5	9,76
493224556	60	faston 6,3mm	50*100 mm	5	12,32



CONDENSATORI DI SPUNTO

In polipropilene, per impiego in corrente alternata, utilizzo per marcia e avviamento motori

Serie: LC03
Tensione: 400/450 Vca
Frequenza: 50/60Hz
IP20
Temp. lavoro: -25°/85°C
Tolleranza: 5%

Adatti per motore
220/380V
trifase alimentato
con 220V monofase



SUPER PROMO!

Per ordini assortiti superiori a €500 sulla gamma condensatori MKC è possibile applicare un ulteriore omaggio di 10 pezzi ogni 40 acquistati.

ARTICOLO	CAPACITÀ µF	TERMINALE	DIMENSIONI LxPxH (mm)	M.O.	PREZZO €
493224500	1,5	faston	30*60M8*10	10	2,03
493224501	2	faston	30*60M8*10	10	2,12
493224502	2,5	faston	30*60M8*10	10	2,20
493224503	3,5	faston	30*60M8*10	10	2,32
493224504	4	faston	30*60M8*10	10	2,35
493224505	4,5	faston	30*60M8*10	10	2,39
493224506	5	faston	30*60M8*10	10	2,43
493224507	6	faston	32*60M8*10	10	2,98
493224508	6,3	faston	32*60M8*10	10	3,09
493224509	7	faston	32*60M8*10	10	3,13
493224510	7,5	faston	32*60M8*10	10	3,15
493224511	8	faston	34*60M8*10	10	3,17
493224512	10	faston	34*68M8*10	10	3,38
493224513	10	con cavetto	34*68M8*10	10	3,83
493224514	11	faston	34*68M8*10	10	3,40
493224515	12	con cavetto	34*68M8*10	10	4,28
493224534	12	faston	34*68M8*10	10	3,36
493224516	14	faston	34*68M8*10	10	3,51
493224517	14	con cavetto	38*70M8*10	10	4,42
493224518	15	faston	38*70M8*10	10	3,53
493224519	16	faston	38*70M8*10	10	4,08
493224520	16	con cavetto	38*70M8*10	10	4,10
493224521	18	faston	38*70M8*10	10	5,23
493224522	20	faston	38*70M8*10	10	5,41
493224523	25	faston	38*70M8*10	10	6,33
493224524	30	faston	38*70M8*10	10	7,30
493224525	31,5	faston	42*80M8*10	10	7,61
493224526	35	faston	42*80M8*10	10	7,76
493224527	40	faston	42*80M8*10	10	8,25
493224528	45	faston	45*90M8*10	10	9,51
493224529	50	faston	45*90M8*10	5	10,05
493224530	60	faston	50*100M8*10	5	12,69
493224531	70	faston	50*100M8*10	5	13,34
493224532	80	faston	50*100M8*10	5	16,51
493224533	100	faston	55*120M8*10	5	21,38

ASSEMBLAGGIO



Box guaine termorestringenti multicolor 100pz
2-3-5-6-8-10mm

Art. 492303865
€ 6,11 M.O.: 5



Box guaine termorestringenti nero 100pz
1,5-2,5-4-6-10-13mm

Art. 492303866
€ 6,11 M.O.: 5



Guaine termorestringenti flessibili in poliolefina 1mt colore nero, confezione sacchetto

ARTICOLO	MODELLO	Ø	PEZZI IN CONF	M.O.	PREZZO €
492303804	9968321	2,4 mm	50	1	87,85
492303805	9968331	3,2 mm	40	1	65,94
492303806	9968341	4,8 mm	30	1	62,28
492303807	9968351	6,4 mm	20	1	53,75

ARTICOLO	MODELLO	Ø	PEZZI IN CONF	M.O.	PREZZO €
492303808	9968361	9,5 mm	10	1	32,46
492303809	9968371	12,7 mm	10	1	40,07
492303810	9968381	16 mm	10	1	48,68
492303813	9968411	38 mm	10	1	123,68



Blocchetto passo 6.35 - 1 coppia

ARTICOLO	TIPO	M.O.	PREZZO €
492518820	2 vie	20	3,19
492518821	4 vie	10	2,16
492518822	6 vie	10	4,37
492518823	8 vie	10	3,39



Faston femmina con 20 cappucci (10 neri e 10 rossi)

ARTICOLO	PASSO	M.O.	PREZZO €
492518800	2.80 x 0.5	20	3,17
492518802	4.80 x 0.5	20	3,58
492518804	6.35 x 0.8	20	2,87

Faston femmina passo 6.35mm
in sacchetto da 100 pz



Art. 492518838
€ 10,52 M.O.: 3

Faston femmina 6.35mm con fermo passo
6.35 x 0.80 Ø 100 pz



Art. 492518805
€ 8,43 M.O.: 10

Faston rosso preisolato femmina
passo 6.35mm, 100 pz



Art. 492518906
€ 21,32 M.O.: 1



Faston maschi con 20 cappucci (10 neri e 10 rossi)
passo 6.35x0.80

Art. 492518806
€ 3,72 M.O.: 20



Faston maschio con il dente di ritenuta
passo 6.35 x 0.80
100 pz

Art. 492518807
€ 10,11 M.O.: 10

REPELLENTI

LS-927 Scacciapi e insetti
professionale ad ultrasuoni



Art. 433358040
€ 34,37 M.O.: 1

Scacciapi e insetti professionale
ad ultrasuoni doppia tecnologia



Art. 433358041
€ 56,13 M.O.: 1



Repellente scaccia volatili sonoro
con sensore pir infrarosso

Art. 433358045
€ 86,23 M.O.: 1



SEGNALATORI ACUSTICI ED OTTICI

QH-925(AC)
Campanello senza fili
unità trasmittente + ricevente



Art. 141400057
€ 23,38 M.O.: 1

QH-913
Campanello senza fili a batterie
unità trasmittente + ricevente



Art. 141400059
€ 18,11 M.O.: 1

PS521 Mini sirena
Tens. nom. 12 Vdc
Pres. acustica 105 Db



Art. 486900101
€ 18,50 M.O.: 1



QH-727
Campanello a chiamata
senza fili a batterie
unità trasmittente + ricevente

Art. 141400060
€ 19,05 M.O.: 1



Diffusore notturno 2 LED
0,5W con interruttore
luce bianca

Art. 141500032
€ 2,81 M.O.: 10

melchioni
mkc

melchioni
mkc

SPRAY STAC PLASTIC



Kit Pulizia monitor

Art. 495338276
€ 7,44 M.O.: 1



NOVITA' PRODOTTO

Spray schiuma lubrificante
scivolante per cavi 400ml

Art. 495338277
€ 8,03 M.O.: 12

ARTICOLO	DESCRIZIONE	M.O.	PREZZO €
495338250	Spray Stac-Air aria compressa 400ml	6	4,88
495338251	Spray Clean-Screen pulitore video 200ml	6	3,94
495338253	Spray alcool isopropilico 200ml	6	6,88
495338254	Spray pulisci contatti secco 200ml	6	4,58
495338255	Spray pulisci contatti oleoso 200ml	6	4,67
495338261	Spray sbloccante 400ml	12	6,02
495338263	Spray igienizzante per climatizzatori 400ml	6	6,46
495338271	Spray sos avvisatore acustico 300ml	12	12,54
495338272	Spray spegnifuoco 500gr	6	12,48
495338273	Colla spray riposizionabile 400ml	1	10,35
495338274	Colla spray permanente 400ml	1	9,83
495338275	Rimuovi colla spray 400ml	1	7,77



stac plastic
SPRAY



CONDIZIONATORI D'ARIA



ALASTOR



CONDIZIONATORE INVERTER CON POMPA DI CALORE

Gas: R32
 Classe: A++/A+
 Con telecomando LCD wireless (batterie non incluse)
 Filtri lavabili
 Timer programmabile
 Display LCD a scomparsa
 Alimentazione: 220-240 V AC 50 Hz

Funzioni:
 Riavvio automatico / Turbo / Blocco bambini
 Sbrinatorio / Deumidificatore

ARTICOLO	TIPOLOGIA	BTU	PESO	DIMENSIONI	M.O.	PREZZO €
----------	-----------	-----	------	------------	------	----------

9.000 BTU

119992000	ALASTOR 9 Unità interna	9.000	8 kg	72,6 x 25 x 20 cm	1	434,93
	ALASTOR 9 Unità esterna	-	25 kg	73,8 x 24,6 x 46,2 cm		

12.000 BTU

119992001	ALASTOR 12 Unità interna	12.000	8,5 kg	82,5 x 29 x 20 cm	1	476,85
	ALASTOR 12 Unità esterna	-	25 kg	73,8 x 24,6 x 46,2 cm		

18.000 BTU

119992002	ALASTOR 18 Unità interna	18.000	10 kg	91 x 32 x 23 cm	1	924,88
	ALASTOR 18 Unità esterna	-	30 kg	80 x 28,5 x 52 cm		

24.000 BTU

119992003	ALASTOR 24 Unità interna	24.000	10 kg	91 x 32 x 23 cm	1	1.087,32
	ALASTOR 24 Unità esterna	-	30 kg	80 x 28,5 x 52 cm		



Consulta il nuovo catalogo Irradio Belair o le schede tecniche sul nostro sito www.melchioni-ready.com



ACCESSORI PER CONDIZIONATORI



IR-AIR Slim Deluxe
 Telecomando per condizionatori d'aria compatibile i maggiori marchi

Art. 559535136
€ 9,89 M.O.: 1



Spray igienizzante
 per climatizzatori
 400ml

Art. 495338263
€ 6,46 M.O.: 6





CONDIZIONATORI D'ARIA

IRRADIO
belair

CONDIZIONATORE INVERTER CON POMPA DI CALORE

Gas: R32
Classe: A++/A+
Telecomando LCD wireless (batterie non incluse)
Filtri lavabili
Timer programmabile
Display LCD a scomparsa
Alimentazione: 220-240 V AC 50 Hz

Funzioni:
Riavvio automatico / Turbo / Blocco bambini
Sbrinatorio / Deumidificatore

NOVITÀ



DUAL SPLIT

ARTICOLO	TIPOLOGIA	BTU	PESO	DIMENSIONI	M.O.	PREZZO €
----------	-----------	-----	------	------------	------	----------

9.000 + 9.000 BTU

119992004	ALASTOR 9 x 2 Unità interna	9.000	8 kg	81,5 x 19,5 x 29 cm	1	1.209,82
	ALASTOR 18 Unità esterna	-	35 kg	82 x 60 x 30 cm		

9.000 + 12.000 BTU

119992005	ALASTOR 9 Unità interna	9.000	8 kg	81,5 x 19,5 x 29 cm	1	1.236,58
	ALASTOR 12 Unità interna	12.000	8 kg	81,5 x 19,5 x 29 cm		
	ALASTOR 18 Unità esterna	-	35 kg	82 x 60 x 30 cm		

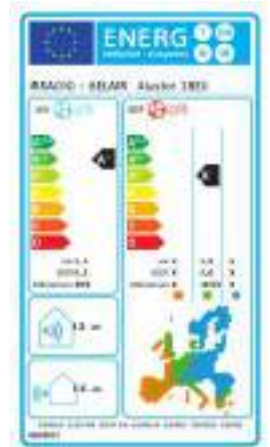

TRIAL SPLIT

ARTICOLO	TIPOLOGIA	BTU	PESO	DIMENSIONI	M.O.	PREZZO €
----------	-----------	-----	------	------------	------	----------

9.000 + 9.000 + 9.000 BTU

119992006	ALASTOR 9 x 3 Unità interna	9.000	8 kg	81,5 x 19,5 x 29 cm	1	1.763,14
	ALASTOR 27 Unità esterna	-	45 kg	92 x 70,5 x 34 cm		

9.000 + 9.000 + 12.000 BTU

119992007	ALASTOR 9 x 2 Unità interna	9.000	8 kg	81,5 x 19,5 x 29 cm	1	1.794,20
	ALASTOR 12 Unità interna	12.000	8 kg	81,5 x 19,5 x 29 cm		
	ALASTOR 27 Unità esterna	-	45 kg	92 x 70,5 x 34 cm		





CONDIZIONATORI D'ARIA PORTATILI

IRRADIO
belair



R290

A



CONDIZIONATORE PORTATILE CON POMPA DI CALORE

Gas: R290
Classe: A
Con telecomando LCD wireless (batterie non incluse)
Con rotelle
Filtri lavabili
Timer programmabile
Rumorosità: 63 db
Assorbimento: 3,7 A
Alimentazione: 220-240 V AC 50 Hz

Funzioni:
Riavvio automatico / Turbo / Sbrinamento
Deumidificatore / Sleep

ARTICOLO	MODELLO	BTU	PESO	DIMENSIONI	M.O.	PREZZO €
7.000 BTU						
158660055	VIGO 7	7.000	25 kg	33,5 x 32,5 x 70,8 cm	1	366,81
9.000 BTU						
158660056	VIGO 9	9.000	26 kg	33,5 x 32,5 x 70,8 cm	1	393,01
NOVITÀ						
12.000 BTU						
158660068	VIGO 12	12.000	25,5 kg	35,5 x 35 x 70 cm	1	484,71



DEUMIDIFICATORI SMART

BALTIC



R290



Gas: R290
Facile da spostare grazie alla maniglia e alle ruote
Modalità Lavanderia (funziona con un'impostazione di umidità del 35%)
Indicatore "Serbatoio pieno"
Controllabile da remoto
Funzione scongelamento intelligente
Swing automatico
Timer 24 ore
Indicatore a colori del livello di umidità nella stanza
Accessorio incluso: tubo di 1m per collegarsi alle acque chiare
Alimentazione: 220-240 V AC 50 Hz

ARTICOLO	MODELLO	CAPACITÀ FLUSSO D'ARIA	DB	PESO	DIMENSIONI CM	M.O.	PREZZO €
158660061	BALTIC 10	10L / 100m³/h	39	25 kg	30 x 23 x 44,3	1	196,50
158660062	BALTIC 16	16L / 140m³/h	41	25 kg	34,5 x 25,5 x 53,2	1	256,76
158660063	BALTIC 20	20L / 170m³/h	42	25 kg	34,5 x 25,5 x 53,2	1	267,25
158660069	BALTIC 25	25L / 210m³/h	42	14,8 kg	36 x 23,4 x 60	1	314,41
158660070	BALTIC 35	35L / 220m³/h	43	16,3 kg	36 x 23,4 x 60	1	379,91





LAVIK

Stufa al quarzo 2.000W con piantana, 2in1 a pavimento e a muro, sia per interni che da esterni

Art. 158640047
€ 132,54 M.O.: 1

MAGMA

Stufa al quarzo 2.200W Per ambienti esterni Completo di ruote piroettanti e maniglia per un facile spostamento

Art. 158640046
€ 93,79 M.O.: 1



VESUVIO

Stufa al quarzo 600W/1.200W maniglie laterali per uso interno

Art. 158660003
€ 40,74 M.O.: 1



SUNNY

Termoventilatore piantana 2.000W, 3 pale D 40cm 2 resistenze al carbonio Funzione oscillazione Altezza: 115cm Base rotonda, con telecomando

Art. 158660023
€ 136,42 M.O.: 1



SUNRISE

Stufa radiante a piantana 1.100W con resistenze al carbonio

Art. 158660008
€ 57,17 M.O.: 1

FIREPLACE NEW

Termoventilatore a colonna 2.000W con effetto legna ardente



Art. 158660009
€ 100,05 M.O.: 1



GOBI

Stufa al carbonio
1.000W
2 resistenze
2 regolazioni potenza
con oscillazione

Art. 158640043
€ 73,89 M.O.: 1



SAHARA

Stufa alogena
3 tubi
1.200W
con rotazione
e tre regolazioni
di potenza

Art. 158640033
€ 58,55 M.O.: 1



VOLCANO

Termoventilatore
a torretta
1.000/2.000W
con resistenza
ceramica

Art. 158640065
€ 113,68 M.O.: 1

STORM

Termoventilatore
ceramico senza pale
1.500W
display LED



Art. 158640041
€ 117,47 M.O.: 1

THERMAL

Termoconvettore 2.000W
con funzione turbo



Art. 158640023
€ 65,37 M.O.: 1

THERMAL PLUS

Termoconvettore 2.000W
3 livelli di potenza selezionabili:
750W / 1.250W / 2.000W



Art. 158660019
€ 78,60 M.O.: 1



MICALIENTE

Termoconvettore
in mica 1.500 W
con griglia
protettiva
e ruote

Art. 158660007
€ 114,35 M.O.: 1



NOVITA' PRODOTTO

**OLIETTO NEW 9
OLIETTO NEW 7**
Radiatori a olio
con ruote

ARTICOLO	MODELLO	CARATTERISTICHE	M.O.	PREZZO €
158660021	OLIETTO NEW 9	9 elementi 2.000W	1	82,90
158660022	OLIETTO NEW 7	7 elementi 1.500W	1	71,45



NOVITA' PRODOTTO



**BLANCO NEW
BLANCO PLUS**

Pannello riscaldante 425W ultrapiatto, verniciabile a risparmio energetico IP44



WARMY WALL

Termoconvettore murale 2.000W, display LED IP22 e telecomando

Art. 158640038

€ 125,05 M.O.: 1

ARTICOLO	MODELLO	CARATTERISTICHE	M.O.	PREZZO €
158660020	BLANCO NEW	425 W	1	99,56
158640040	BLANCO PLUS	425 W con display	1	144,00

BOOSTER

Termoventilatore ceramico 3.000W con termostato



Art. 158640028

€ 93,79 M.O.: 1

CALIDO

Termoventilatore ceramico 1.500W con oscillazione e comoda maniglia



Art. 158640045

€ 48,32 M.O.: 1

HOTTY

Termoventilatore 2.000W 1 regolazione aria fredda 2 regolazioni aria calda (1.000/2.000W)



Art. 158640022

€ 22,74 M.O.: 1

HOTTY PLUS

Termoventilatore 2.000W termostato, possibilità di posizionarlo sia in orizzontale che in verticale



Art. 158640044

€ 29,84 M.O.: 1

BUGGY Assortito / WOOL

Borsa dell'acqua calda elettrica, con tasca scaldamani. Temperatura fino a 70°C. Riscaldamento in 8/15 minuti. Durata del calore fino a 6 ore.



NOVITA' PRODOTTO

BUGGY assortito 6 pezzi

Tessuto in flanella con stampa fantasia.

Art. 158660001

€ 18,34 M.O.: 6



BUGGY WOOL

Tessuto in pile imbottito, colore grigio.

Art. 158660002

€ 19,89 M.O.: 1



GOODNIGHT

Scaldaletto elettrici in poliestere o lana sintetica

	ARTICOLO	MODELLO	MATERIALE	CARATTERISTICHE	M.O.	PREZZO €
1	158660010	GOODNIGHT	Poliestere	150x80cm / 60W	1	28,59
2	158660011			160x140cm / 120W	1	51,46
3	158660012		Lana sintetica	150x80cm / 60W	1	40,02
4	158660013			160x140cm / 120W	1	68,61

HUG

Termocoperta elettrica 85W in flanella e pile sherpa 160x130cm



Art. 158660014
€ 65,75 M.O.: 1

BORA BORA

Stendino riscaldato verticale 300W 3 ripiani con ruote

Art. 158660006
€ 214,40 M.O.: 1



BAHAMAS

Stendino elettrico riscaldato con ali 230W

Art. 158660005
€ 94,74 M.O.: 1





**MF 2403T30
MF 2404T40**

Ventilatori da tavolo 30W e 35W
diametro 30 e 40 cm, funzione oscillazione
griglia nido d'ape, 3 velocità, colore bianco

ARTICOLO	MODELLO	M.O.	PREZZO €
118620056	MF 2403T30	1	28,42
118620057	MF 2404T40	1	33,16

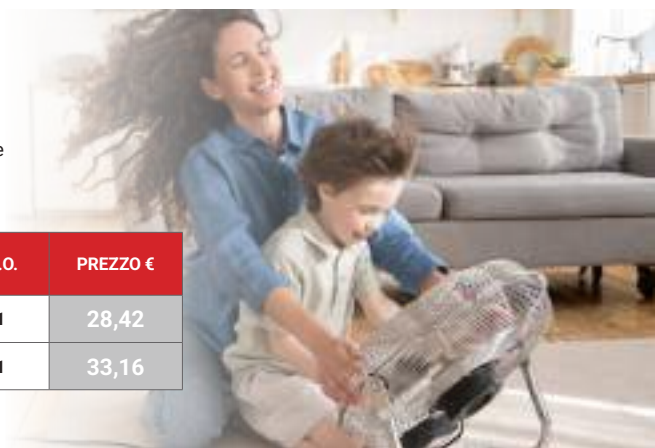

MF 2519BLS

Ventilatore senza pale
Ventilazione su 3 velocità
Funzione oscillazione
Timer: 7,5 ore
Con telecomando

Art. 118620071
€ 117,90 M.O.: 1



MF 2508SPD

Ventilatore piantana
con testa reclinabile 90°
Ventilazione su 8 velocità
Funzione oscillazione
Timer 12h
Spegnimento automatico
Con telecomando

Art. 118620073
€ 86,90 M.O.: 1



MF 242IN1

Termoventilatore 1600/2100W
funzione aria fredda (2 velocità)
e aria calda (2 velocità)
e superamento del calore
oscillazione e movimento
up&down, altezza regolabile
pannello comandi
e telecomando
colore bianco

Art. 118620066
€ 168,35 M.O.: 1



MF 2412BF

Box fan con timer 40W
diametro 30 cm
5 pale in polipropilene
3 velocità, timer da 60min
colore grigio

Art. 118620061
€ 41,90 M.O.: 1



**MF 2460IND
MF 2475IND**

Ventilatori industriali
diametro 60cm, 75cm
110W, 124W
interruttore a pulsante
maniglia e ruote
per un facile trasporto
3 velocità
3 pale in alluminio

ARTICOLO	MODELLO	CARATTERISTICHE	M.O.	PREZZO €
118620063	MF 2460IND	60cm / 110W	1	183,40
118620064	MF 2475IND	75cm / 124W	1	222,70

NOVITA' PRODOTTO



MF 2675IND
 Ventilatore industriale da parete da 75cm
 3 velocità
 3 pale in alluminio
 Diametro: 75cm
 Oscillazione 85°
 Alimentazione: 220 - 240 V AC 50 Hz
 Assorbimento: 200 W

Scopri di più su
www.melchioni-ready.com



Art. 118620079
€ 117,90 M.O.: 1



MF 2505CEI
 Agitatore da soffitto 5 pale
 Ventilazione su 6 velocità
 Inversione della rotazione
 Luce LED con 3 temperature di colore
 Arresto temporizzato, con telecomando
 Alimentazione: 22/240 VAC 50Hz
 Assorbimento: 100W



Art. 118620072
€ 149,37 M.O.: 1



MF 2503CEI
 Agitatore da soffitto 3 pale
 Ventilazione su 6 velocità
 Inversione della rotazione
 Luce LED con 3 temperature di colore
 Arresto temporizzato, con telecomando
 Alimentazione: 22/240 VAC 50Hz
 Assorbimento: 65W

Art. 118620074
€ 176,52 M.O.: 1

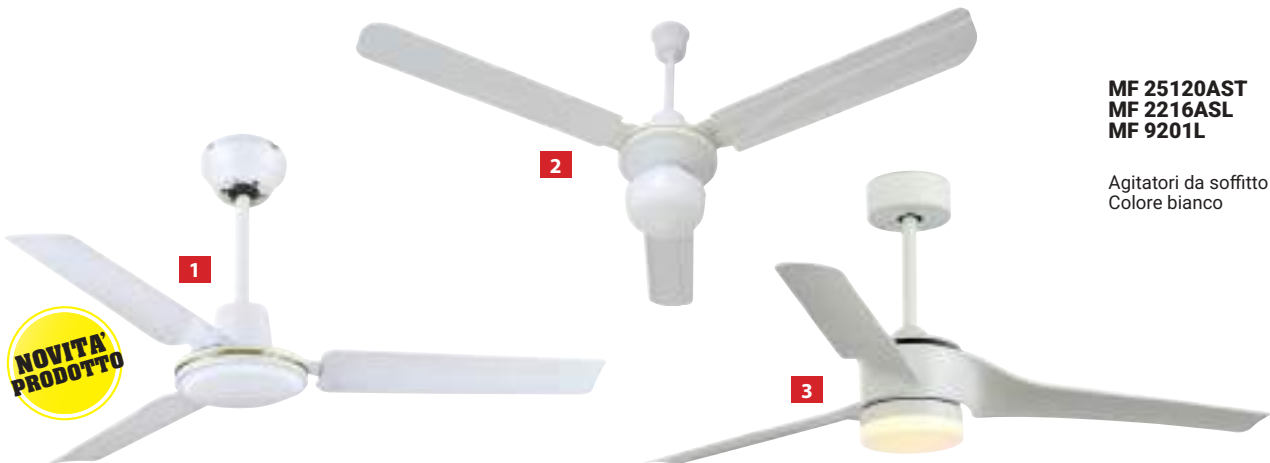

MF 25120AST
MF 2216ASL
MF 9201L

Agitatori da soffitto
 Colore bianco

NOVITA' PRODOTTO

ARTICOLO	MODELLO	CARATTERISTICHE	M.O.	PREZZO €
1	118620075 MF 25120AST	65W, 120 cm, pale in metallo, 5 velocità, controllo a parete	1	70,74
2	118620049 MF 2216ASL	65W, 120 cm, pale in metallo, luce integrata (E27 60W), 5 velocità, controllo a parete	1	78,32
3	118620055 MF 9201L	45W, 132cm, pale in ABS, luce LED integrata, 6 velocità, controllo con telecomando, 3 modalità: Normal / Natural / Sleep, rotazione inverno/estate	1	259,39



Ventilatori da campeggio ricaricabili con luce LED

MF 0501VL

Ventola Ø 10 cm
Telecomando, Timer 2, 3, 5 h
Batteria: 18.650/5.200 mAh
Autonomia (carica compl.) 6-25 h
Gancio per essere appeso
Tensione d'ingresso: DC 5V 2A
Potenza in uscita: 1W/6W
Potenza del LED: 0.5W/2W



Art. 118620050

€ 45,00 M.O.: 1

MF 0612VL

Ventola Ø 12 cm
Batteria: 18.650/5.200 mAh
Autonomia (carica compl.) 6-25 h
Tensione d'ingresso: DC 5V 2A
Potenza in uscita: 1W/6W
Potenza del LED: 0.5W/2W



Art. 118620051

€ 55,00 M.O.: 1

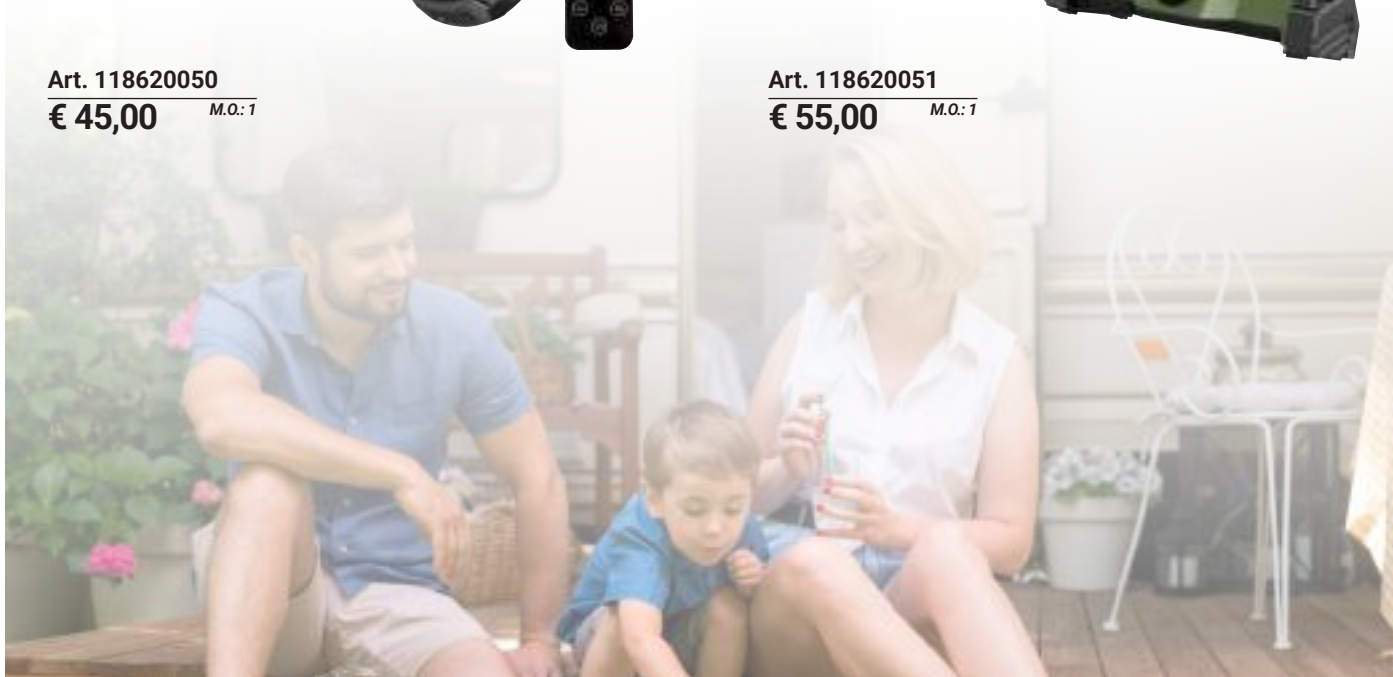

ZANZARIERE



CAGE

Zanzariera con ventola 2W
Materiale ABS, Ventola silenziosa
Spina girevole, UV LED a frequenza specifica per non danneggiare gli occhi
Vassoio di raccolta sul fondo facile da pulire, Copertura 20m²

Art. 118620067

€ 20,10 M.O.: 1



TORCIA

Zanzariera elettrica 10W da appendere, interno
Lampada UVA, Tensione 1.000V
Durata 8.000 ore, Involucro in ABS
Vassoio di raccolta removibile
Spazzola per la pulizia inclusa
Colore nero
Copertura: 30m²

Art. 118620068

€ 23,08 M.O.: 1



LANTERNA

Zanzariera elettrica 20W da appendere, interno
Materiale ABS, Lampada UV
Durata 8.000 ore
Vassoio di raccolta removibile sul fondo
Applicazione: esterno
Copertura: 50m²

Art. 118620070

€ 44,80 M.O.: 1

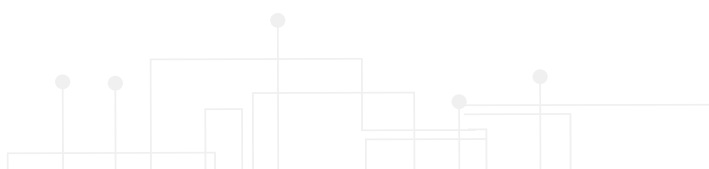

GLACIALE 40 | GLACIALE 50

Frigo portatile rigido con compressore **Classe D**
 Scomparto refrigerante/freddo | Temp. regolabile: +10 ~ -18°C
 Maniglie retraibili per un facile trasporto
 Pannello di controllo con display LED
 Luce LED interna | Cavo auto 12V incluso
 Alimentatore di rete 220V non incluso,
 disponibile come accessorio (118700250)
 Alimentazione: DC12/24V AC100~240V 50-60Hz



* Alimentatore frigo Glaciale

Alimentatore di rete 220V non incluso
 nella confezione dei frigo Glaciale,
 disponibile come accessorio

ARTICOLO	MODELLO	CAPACITÀ	M.O.	PREZZO €
118700248	GLACIALE 40	37 lt	1	340,61
118700249	GLACIALE 50	46 lt	1	366,81
118700250	Alimentatore di rete 220V *		1	22,27

CONSERVO 24 | CONSERVO 30

Frigo portatile rigido 12/220-240V
 freddo/caldo, **Classe E**



ARTICOLO	MODELLO	CAPACITÀ	M.O.	PREZZO €
118700227	CONSERVO 24	21 lt	1	91,70
118700228	CONSERVO 30	27 lt	1	113,97





Una gamma di prodotti **unica e disponibile a magazzino in Italia** e fruibile su una **piattaforma d'acquisto realmente innovativa**, che utilizza i più evoluti strumenti software per ottimizzare l'esperienza d'acquisto degli utenti.

Melchioni Ready offre un servizio in grado di rispondere a tutte le esigenze del cliente: **semplicità nell'acquisto, consegna rapida, affidabilità e convenienza.**



Nessun minimo d'ordine



Logistica avanzata



Ordini senza intoppi

segui Melchioni Ready su



Melchioni S.p.A.

Via P. Colletta, 37 20135 Milano
clienti-ready@melchioni.com | www.melchioni-ready.com