

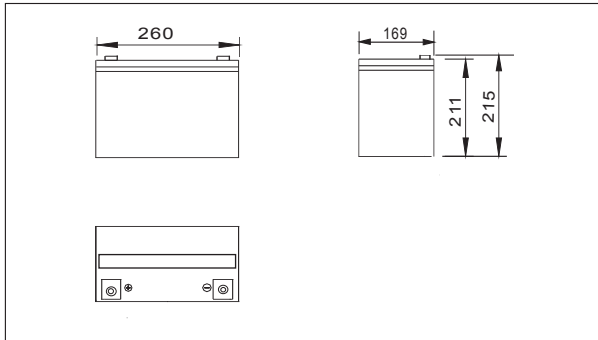

Specifications

Nominal Voltage	12V	
Rated capacity (10 hour rate)	80Ah	
Dimensions	Length	260±2mm(10.24inch)
	Width	168±2mm(6.61inch)
	Height	211±2mm(8.31inch)
	Total Height	215±2mm(8.46inch)
Approx. Weight	22.5kg(49.6lbs)±3%	

Outer dimensions (mm)



Terminal Type (mm)

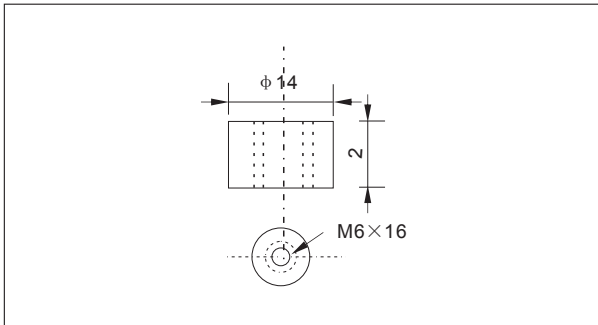

Construction

Component	Positive plate	Negative plate	Container	Cover	Separator	Electrolyte	Safety valve	Terminal
Raw material	Lead dioxide	Lead	ABS	ABS	AGM	Sulfuric acid	Rubber	Copper

Constant Current Discharge Characteristics Unit:A(25°C,77°F)

F.V/Time	10min	15min	30min	60min	2h	3h	4h	5h	8h	10h	20h
9.60V	153	118	70.4	43.3	25.6	18.4	14.7	12.6	8.64	7.13	3.78
9.90V	148	115	68.9	42.6	25.4	18.3	14.6	12.5	8.59	7.11	3.77
10.2V	142	111	66.8	41.5	25.2	18.2	14.5	12.4	5.53	7.09	3.76
10.5V	136	107	65.2	40.2	24.8	18.1	14.4	12.3	8.47	7.05	3.74
10.8V	128	101	62.8	38.9	24.2	17.5	14.0	12.0	8.22	7.00	3.71

Constant Power Discharge Characteristics Unit:W(25°C,77°F)

F.V/Time	10min	15min	30min	60min	2h	3h	4h	5h	8h	10h	20h
9.60V	1648	1291	789	493	296	217	173	149	103	85.1	45.3
9.90V	1599	1260	774	486	294	215	172	148	102	84.9	45.2
10.2V	1533	1214	750	473	292	214	171	147	101	84.7	45.1
10.5V	1467	1172	732	459	287	212	170	146	101	84.2	44.8
10.8V	1384	1110	705	444	280	206	164	141	97.6	83.6	44.5

Note: The above characteristics data can be obtained within three charge or discharge cycles.

Characteristics

Capacity (25°C)	10HR(10.8V)	80Ah
	3HR(10.8V)	52.5Ah
	1HR(10.5V)	39Ah
Terminal type		M6
Internal resistance (Fully charged, 25°C)		Approx. 6mΩ
Capacity affected by temperature (10HR)	40°C	102%
	25°C	100%
	0°C	85%
	-15°C	65%
Self-discharge (25°C)	3month	Remaining Capacity:91%
	6month	Remaining Capacity:82%
	12month	Remaining Capacity:65%
Nominal operating temperature		25°C ± 3°C (77°F ± 5°F)
Operating temperature range	Discharge	-15°C~50°C (5°F~122°F)
	Charge	-10°C~50°C (14°F~122°F)
	Storage	-20°C~50°C (-4°F~122°F)
Float charging voltage(25°C)		13.50 to 13.80V Temperature compensation: -18mV/°C
Cyclic charging voltage(25°C)		14.50 to 15.00V Temperature compensation: -30mV/°C
Maximum charging current		21A
Terminal material		Copper
Maximum discharge current		700A(5 sec.)
Designed floating life(20°C)		10years

● Discharge characteristics(25°C)

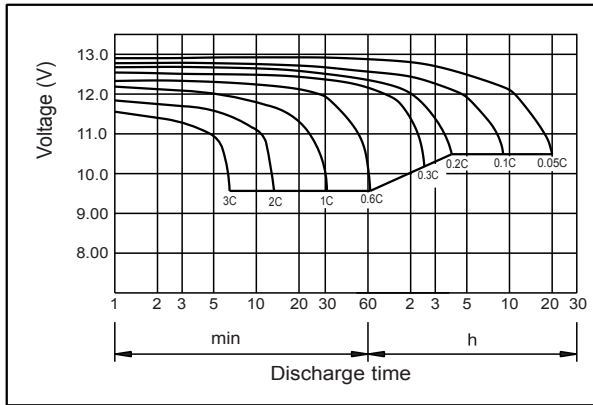

● Charging characteristics (25°C)

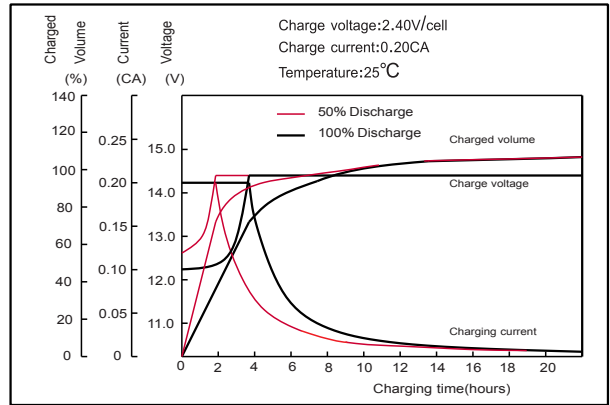

● Temperature effects on Capacity

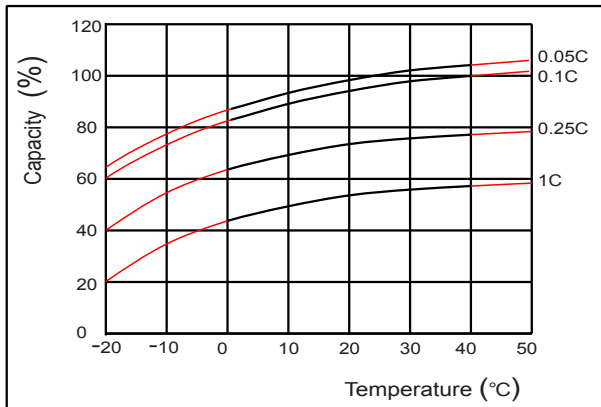

● Self-discharge characteristics

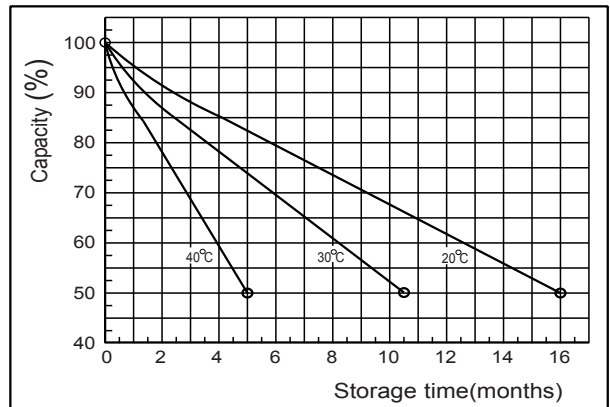

● Floating life on Temperature

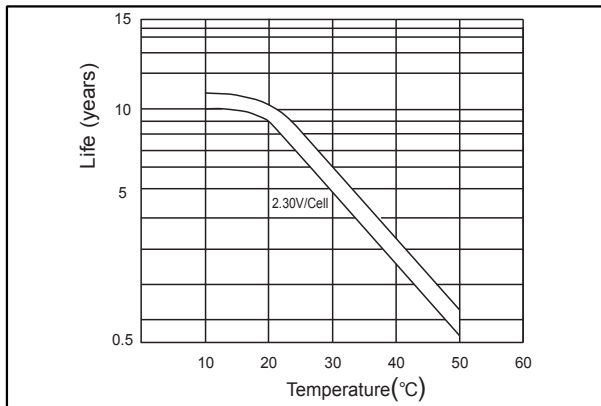

● Cycle life on D.O.D (25°C)

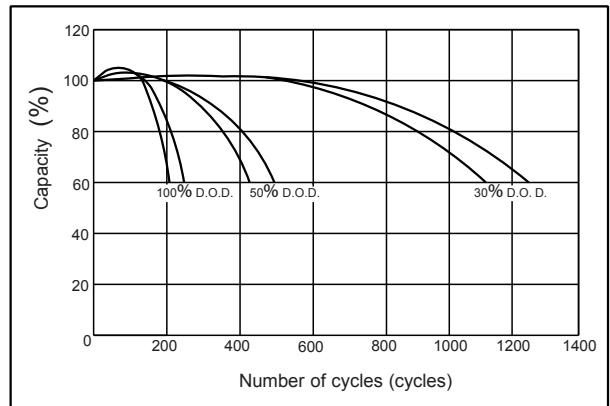

● The relationship for OCV and Capacity (25°C)

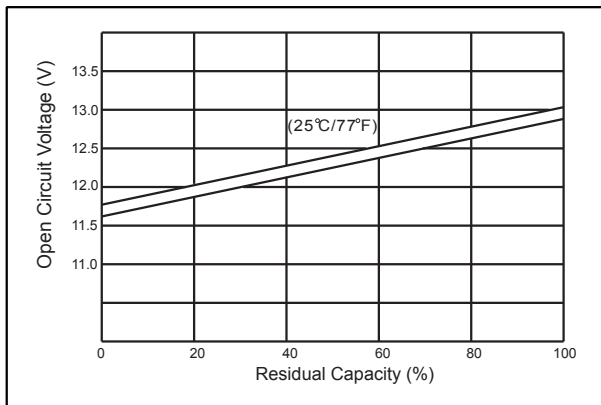

● The relationship for Charging voltage and Temperature

