

## FEATURES

- FADER+DIMMER+DRIVER
- DC Input: 12-24-48 Vdc or 12-24 Vdc
- MULTI INPUT – Analogic Automatic Detection of the Local command:
  - Normally Open push-button
  - Analog input 0-10V
  - Analog input 1-10V
  - Potentiometer 10KOhm
- PUSH MENU’ – Possibility to set:
  - Minimum value of dimming
  - Fade In
  - Fade Out
- Constant Voltage variant for Common Anode applications
- Voltage outputs for R-L-C loads, DLM1248-1CV variant
- Voltage outputs for R loads, DLM1224-1CV variant
- Memory function
- Adjusting the brightness of white light or monochromatic color
- Adjusting the brightness up to completed off
- Soft start and soft stop
- Sync function - Master/Slave
- Optimized output curve
- Typical efficiency > 95%
- 100% Functional test – 5 Years warranty

➔ For the whole and updated **Device Manual** refer to producer’s website: <http://www.dalcnet.com>

## ➤ CONSTANT VOLTAGE VARIANTS

Application: Dimmer



CODE	Input voltage	Output	Channels	Analogic Auto Detection
DLM1248-1CV	12-48V DC	1 x 6,5A	1	N° 1 N.O. Push Button N° 1 analog signal 0-10V N° 1 analog signal 1-10V N° 1 Potentiometer 10K
DLM1224-1CV	12-24V DC	1 x 10A	1	N° 1 N.O. Push Button N° 1 analog signal 0-10V N° 1 analog signal 1-10V N° 1 Potentiometer 10K

The LED dimmer is produced by default with:

- Analogic Automatic Detection of local command set as N.O. Push Button
- Dimming minimum level 1%

## ➤ PROTECTIONS

		DLM1248-1CV	DLM1224-1CV
<b>OTP</b>	Over temperature protection <sup>1</sup>	✓	✗
<b>OVP</b>	Over voltage protection <sup>2</sup>	✓	✓
<b>UVP</b>	Under voltage protection <sup>2</sup>	✓	✓
<b>RVP</b>	Reverse polarity protection <sup>2</sup>	✓	✓
<b>IFP</b>	Input fuse protection <sup>2</sup>	✓	✓
<b>SCP</b>	Short circuit protection	✓	✗
<b>OCP</b>	Open circuit protection	✗	✓
<b>CLP</b>	Current limit protection	✓	✗

<sup>1</sup> Thermal Protection on the output channel in case of high temperature. The thermal intervention is detected by transistor.

<sup>2</sup> Only control Logic protection.



## ➤ REFERENCE STANDARDS

EN 61347-1	Lamp controlgear - Part 1: General and safety requirements
EN 55015	Limits and methods of measurement of radio disturbance characteristics of electrical lighting and similar equipment
EN 61547	Equipment for general lighting purposes - EMC immunity requirements
IEC 60929-E.2.1	Control interface for controllable ballasts - control by d.c. voltage - functional specification
ANSI E 1.3	Entertainment Technology - Lighting Control Systems - 0 to 10V Analog Control Specification

## ➤ TECHNICAL SPECIFICATIONS

	DLM1248-1CV Variant	DLM1224-1CV Variant
	Constant voltage	Constant voltage
Supply voltage	min: 10,8 Vdc .. max: 52,8 Vdc	min: 10,8 Vdc .. max: 26,4 Vdc
Output voltage	= Vin	= Vin
Input current	max 6,5A	max 10A
Output current	6,5A <sup>3</sup>	10A <sup>3</sup>
Absorbed nominal power <sup>3</sup>	@12V	78 W
	@24V	156 W
	@48V	312 W
Power loss in standby mode	<500mW	<500mW
Type of Load	R – L – C	R
Thermal shutdown <sup>4</sup>	150°C	-
Command supply current	0,5mA (per 1-10V)	0,5mA (per 1-10V)
Command required current (max)	0,1mA (per 0-10V)	0,1mA (per 0-10V)
D-PWM dimming frequency	300Hz	300Hz
D-PWM resolution	16 bit	16 bit
D-PWM range	0,1 – 100%	0,1 – 100%
Storage Temperature	min: -40 max: +60 °C	min: -40 max: +60 °C
Ambient Temperature	min: -10 max: +40 °C	min: -10 max: +40 °C
Wiring	2.5mm <sup>2</sup> solid – 2.5mm <sup>2</sup> stranded – 30/12 AWG	1.5mm <sup>2</sup> solid – 1mm <sup>2</sup> stranded – 30/16 AWG
Wire preparation length	5.5 – 6.5 mm	5 – 6 mm
Protection grade	IP20	IP20
Casing material	Plastic	Plastic
Packaging unit (pieces/unit)	Single Carton Box 1 pz	Carton Box 10pz
Mechanical dimensions	44 x 57 x 25 mm	44 x 57 x 19 mm
Package dimensions	56 x 68 x 35 mm	164 x 117x 70 mm
Weight	40g	306g

<sup>3</sup> Maximum value, dependent on the ventilation conditions. This value is measured at 40°C, it is maximum ambient temperature.

<sup>4</sup> Thermal Protection on the output channel in case of high temperature. The thermal intervention is detected by transistor.

## ➤ INSTALLATION

To set the product, follow the instruction on the picture below:

- 1) connect the power supply (12-24 Vdc or 12-48 Vdc depending on the dimmer model) to terminal blocks “DC IN” of the device.
- 2) connect the LOCAL COMMAND to the terminal blocks “INPUT” of the device.
- 3) connect the LED in the output terminal blocks “OUT” of the device.

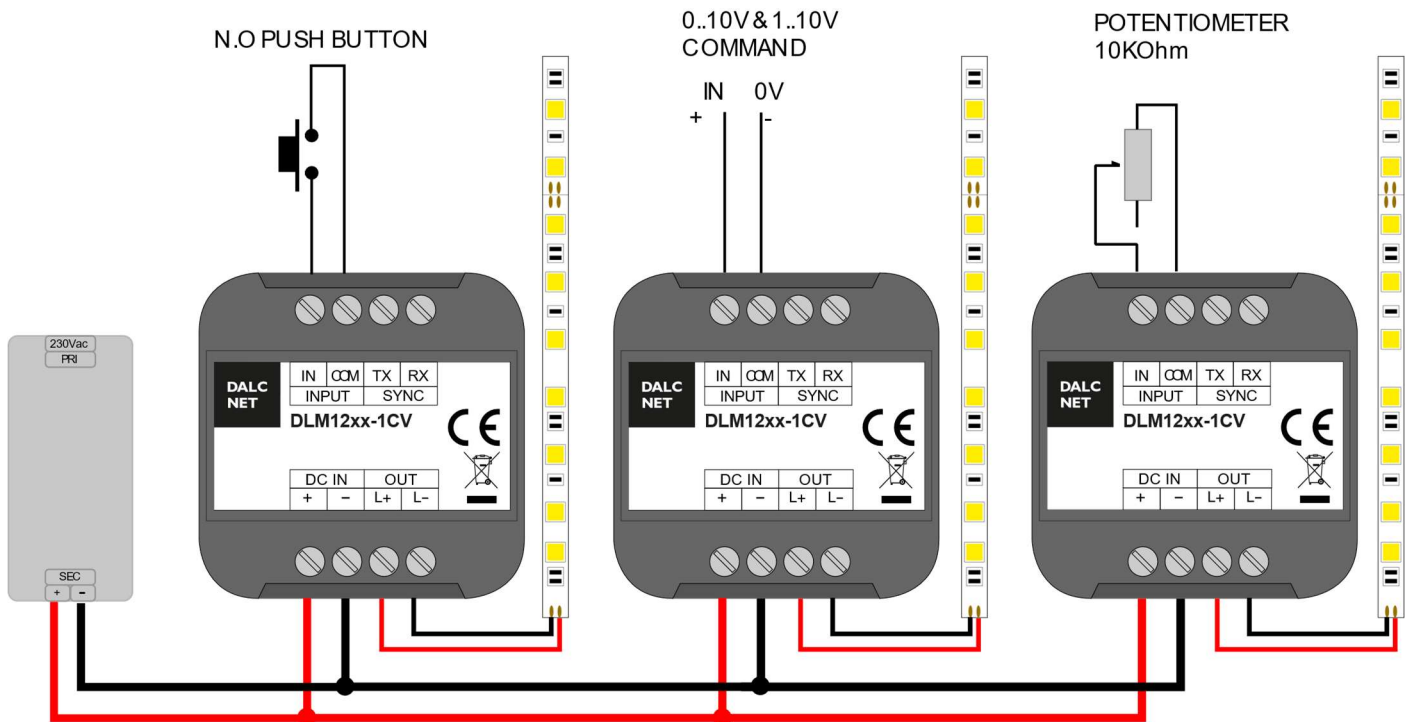

**➤ PUSH DIMMER FEATURE**

The intensity and the status change (ON/OFF) are controlled by the N.O. push button.

Button	Intensity
Click	On/Off
Double Click	Maximum intensity
Long pressure (>1s) from OFF	Turn ON at 1% (Nightly Time), then dimmer up/down
Long pressure (>1s) from ON	Dimmer up/down
15 Click in 5 second-time	Enter in to PUSH MENU'

**➤ 0-10V & 1-10V & POTENTIOMETER FEATURE**

The intensity is controlled by input voltage variation.

Button	Function	Intensity
0-10V		Dimmer: 0-1V=0%
1-10V		10V=100%
Potentiometer 10K		

**➤ PUSH MENU'****FUNCTION AVAILABLE**

- ❖ MINIMUM VALUE OF DIMMING
- ❖ POWER-ON RAMP (FADE IN)
- ❖ POWER-OFF RAMP (FADE OUT)

**ACCESS TO MENU'**

When you turn-on the LED dimmer, the output is set at 100% and the minimum of dimming is at 1 %.

To access the device menu, click the push button 15 times in 5 seconds time.

When the Load flashes, you are in "MENU' 1".

- **MENU' 1 – MINIMUM VALUE OF DIMMING**

Every single click make it changing the minimum value of dimming  
There are six level of minimum: 0,1%, 1%, 5%, 10%, 20%, 30% and 100%

After setting the minimum value of dimming press long to confirm.  
A double flashing confirms the storage and you can go to "MENU' 2"

Note: if you set the minimum level to 100%, once the settings is confirmed, the device automatically exits the MENU'.

- **MENU' 2 – POWER-ON RAMP (FADE IN)**

Every single click make it changing the power-on ramp  
There are five levels of power-on ramp (FADE IN): Instantaneous, 1 second, 2 seconds, 3 seconds, 6 seconds.

After setting the FADE IN press a long to confirm.  
Three flashes confirm the storage and you can go to "MENU' 3"

- **MENU' 3 – POWER-OFF RAMP (FADE OUT)**

Every single click make it changing the power-off ramp  
There are five levels of power-off ramp (FADE OUT): Instantaneous, 1 second, 2 seconds, 3 seconds, 6 seconds.

After setting the FADE OUT press long to confirm.  
Three quick flashes confirm the storage and you go out from the "DEVICE MENU"

When you are out of the Menu', the Lamp which is connected to the LED Dimmer turns on at the minimum level of dimming previously set.

➤ **LOCAL COMMAND**





AUTOMATIC DETECTION OF THE TYPE OF LOCAL COMMAND

At the first switch the device is set by default to automatic recognition of push button N.O. Command.

❖ **AUTOMATIC DETECTION OF THE 0/1-10V & POTENTIOMETER COMMAND**

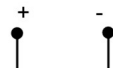
The automatic recognition of analog signal 0/1-10V or potentiometer starts as a 0/1-10V value between 3V and 7V is sent out or setting the potentiometer with a value included from 30% and 70%.

COMMAND 0-10V	COMMAND 1-10V	POTENTIOMETER																								
<p>0..10V</p>  <table border="1"> <tr> <td>IN</td> <td>COM</td> <td>TX</td> <td>RX</td> </tr> <tr> <td colspan="2">INPUT</td> <td colspan="2">SYNC</td> </tr> </table>	IN	COM	TX	RX	INPUT		SYNC		<p>1..10V</p>  <table border="1"> <tr> <td>IN</td> <td>COM</td> <td>TX</td> <td>RX</td> </tr> <tr> <td colspan="2">INPUT</td> <td colspan="2">SYNC</td> </tr> </table>	IN	COM	TX	RX	INPUT		SYNC		<p>10KΩ</p>  <table border="1"> <tr> <td>IN</td> <td>COM</td> <td>TX</td> <td>RX</td> </tr> <tr> <td colspan="2">INPUT</td> <td colspan="2">SYNC</td> </tr> </table>	IN	COM	TX	RX	INPUT		SYNC	
IN	COM	TX	RX																							
INPUT		SYNC																								
IN	COM	TX	RX																							
INPUT		SYNC																								
IN	COM	TX	RX																							
INPUT		SYNC																								

❖ **AUTOMATIC DETECTION OF THE N.O. PUSH BUTTON COMMAND**

The N.O. push button s identified automatically after 5 clicks in rapid sequence.  
In mode N.O. push button, function memory is always active.

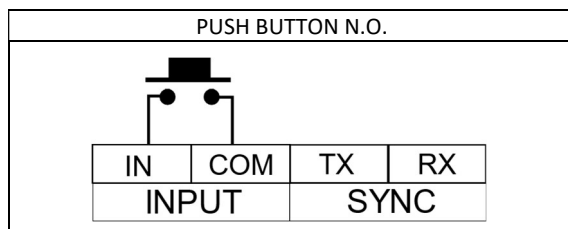

## ➤ SYNC INSTALLATION

### SYNC FUNCTION WITH SINGLE POWER SUPPLY

It is possible to connect multiple device of the family DLM-1CV among them in mode Master/Slave  
Connect the local command desired to the device used as Master. Connect master "TX" signal to the "RX" entrances of slave.  
Example of Master/Slave:

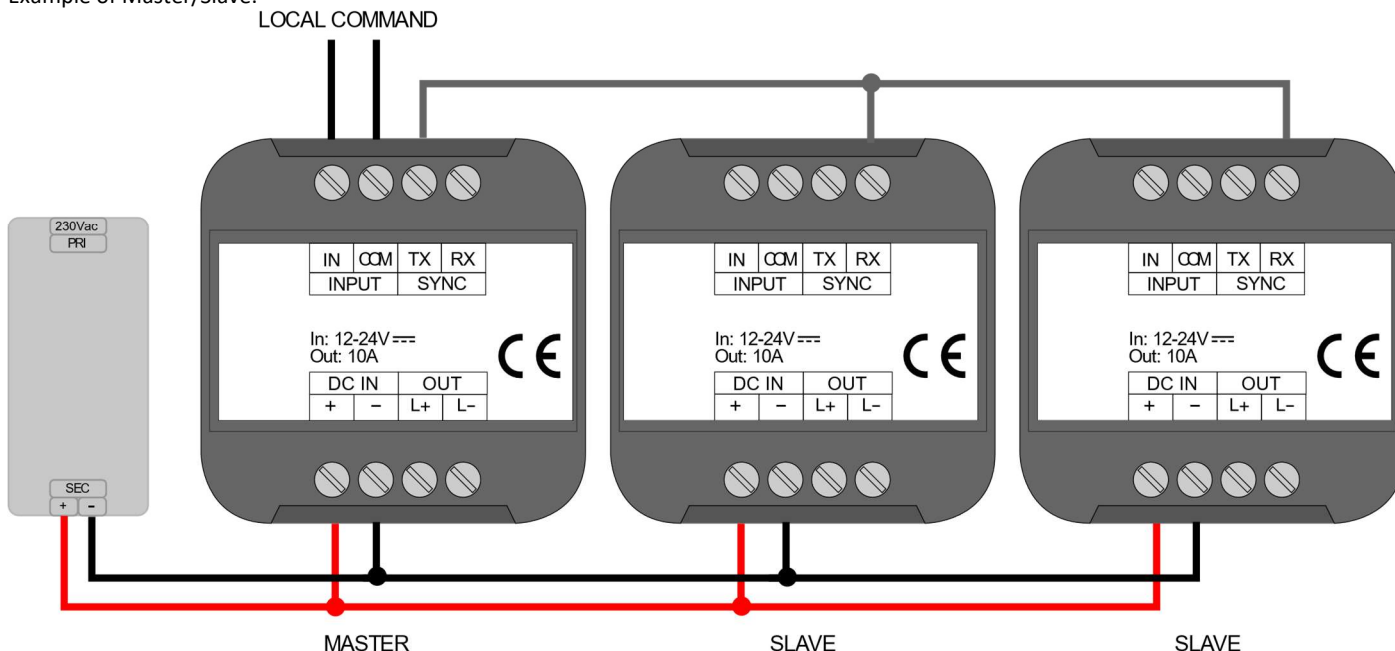

### SYNC FUNCTION WITH ONE POWER SUPPLY FOR DIMMER

In the case multiple power supplies are used to power "master" dimmer and "slave" dimmers, connect all the "COM" inputs of the LedDimmer to each other.

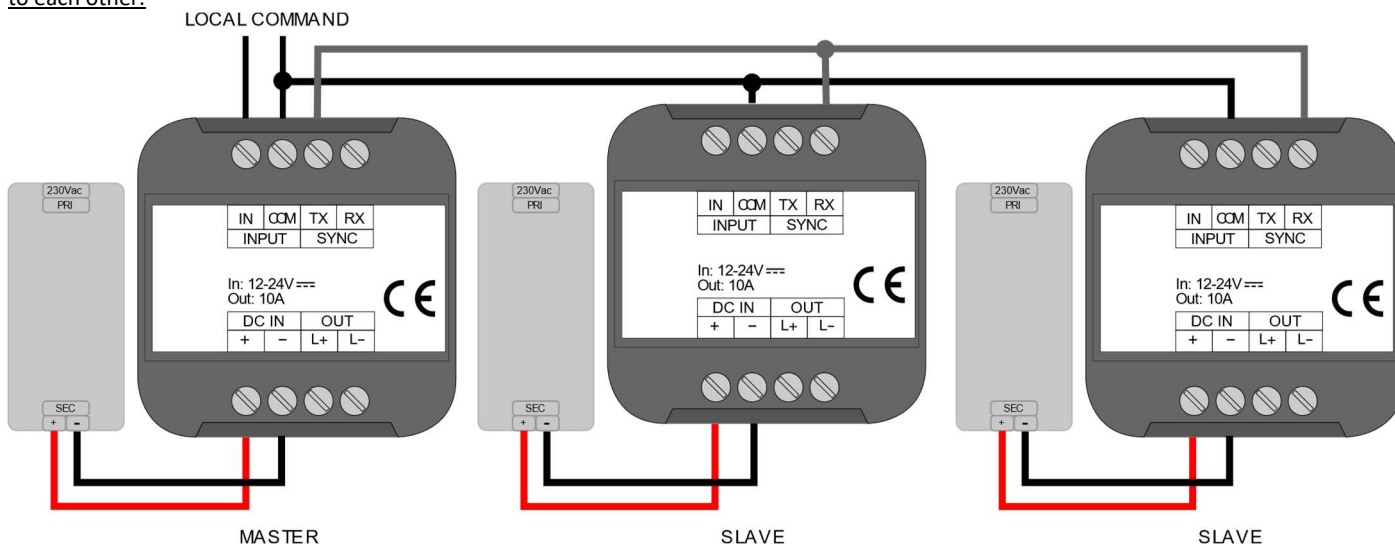

### NOTE FOR MASTER/SLAVE INSTALLATION

- 1) Using one power supply every single dimmer, first power on the Master unit and after that give power to the Slave.
- 2) When doing maintenance on the installation take care of shutting down power to the Slave units first and then to the Master.
- 3) When power to the Master unit is missing, the Slave set up automatically to the default ex-factory settings (power on 100%) or to the settings previously saved.

➤ **TECHNICAL NOTE**

Installation:

- Installation and maintenance must be performed only by qualified personnel in compliance with current regulations.
- The product must be installed inside an electrical panel protected against overvoltages.
- The product must be installed in a vertical or horizontal position with the cover / label upwards or vertically; Other positions are not permitted. It is not permitted to bottom-up position (with the cover / label down).
- Keep separated the circuits at 230V (LV) and the circuits not SELV from circuits to low voltage (SELV) and from any connection with this product. It is absolutely forbidden to connect, for any reason whatsoever, directly or indirectly, the 230V mains voltage to the bus or to other parts of the circuit.

Power supply:

- For the power supply use only a SELV power supplies with limited current, short circuit protection and the power must be dimensioned correctly. In case of using power supply with ground terminals, all points of the protective earth (PE = Protection Earth) must be connected to a valid and certified protection earth.
- The connection cables between the power source "low voltage" and the product must be dimensioned correctly and they should be isolated from every wiring or parts at voltage not SELV. Use double insulated cables.
- Dimension the power supply for the load connected to the device. If the power supply is oversized compared with the maximum absorbed current, insert a protection against over-current between the power supply and the device.

Command:

- The length of the connection cables between the local commands (N.O. Push button, 0-10V, 1-10V, Potentiometer or other) and the product must be less than 10m; the cables must be dimensioned correctly and they should be isolated from every wiring or parts at voltage not SELV. Use double insulated shielded and twisted cables.
- The length and type of the connection cables at the BUS SYNC must be less than 3m and they should be isolated from every wiring or parts at voltage not SELV. It is suggested to use double insulated shielded and twisted cables.
- All the product and the control signal connect at the bus and at the local command (N.O. Push button, 0-10V, 1-10V, Potentiometer or other) must be SELV (the devices connected must be SELV or supply a SELV signal)

Outputs:

- The length of the connection cables between the product and the LED module must be less than 10m; the cables must be dimensioned correctly and they should be isolated from every wiring or parts at voltage not SELV. Is preferable to use shielded and twisted cables.

➤ **MECHANICAL DIMENSION**

DLM1224-1CV

DLM1248-1CV

